



Product range and accessories

Edition 4.1

**ACTIVELY LOWERING OUR
CARBON FOOTPRINT.**

Produced on carbon-offset paper,
printed using a renewable energy
source and delivery which is
carbon-offset too!



New in this edition:

- iWOW® Dual 'vertical'
- iWOW® Plus 1, 5 and 8-drawer
- iWOW® LiFe AC x 4 models



Available on



NHS Supply Chain

CONTENTS

8

iWOW® main components and features

A brief explanation on the main features and benefits for the prominent components and technologies.



24

iWOW® hook-over and custom accessories

Handy optional hook-over attachments for sharps, gels, gloves and more.



36

iWOW®

The original iWOW® Adjustable height intelligent workstation on wheels!



42

iWOW® Keyboard

iWOW® with integrated keyboard and mouse shelf.



48

iWOW® Dual

A dual monitor option now in a space saving 'stacked' configuration.

NEW



54

iWOW® Plus

Integrated storage, keyboard shelf and accessory rails now in 4 new models.

NEW



70

iWOW® Fixed 600

Our fixed height model - 600mm wide. With up to 4 accessory rails.



74

iWOW® Fixed 800

Our fixed height model - 800mm wide. With up to 4 accessory rails and HTM71 tray system.



82

iWOW® Duo

A tablet-docking workstation on wheels!



88

Custom Workstations

The brand new ITU Custom workstations!

NEW



98

iWOW® LiFe (AC power)

Mobile AC power now available as 4 dedicated iWOW® models.

NEW



120

Medical Monitors and AIOs

State-of-the-art touch screen monitors and AIOs.



196

Medical Tablet PC

Our powerful new 13in Intel® Core i7 powered Tablet and accessories.



208

Accessories/ Peripherals

Battery Pack/ 6-bay Charger/ Medical Keyboard/ Medical Mouse



All products available on NHS Supply Chain via eDirect.

AN INTRODUCTION



An Intelligent Workstation on Wheels - iWOW®

From decades of product development at our sister company Freeway Medical, Freeway Med-Tech now brings cutting edge technology to the portfolio.

Using the same methodical approach to design, manufacture and delivery, our new range of mobile iWOW® workstations are proving to be very popular indeed.

With lots of features, options and customisable solutions available, the Freeway Med-Tech iWOW® range has to be seen to be believed. And what's even more impressive, is how competitively they're priced. You'll be surprised!

Familiarise yourself with iWOW® and its technologies >

WHAT MAKES AN iWOW®

A great product is the sum of its parts.

Each area of our iWOW® is designed to not only outperform its competitors, but to outlast them as well. This makes for an extremely cost effective way to incorporate mobile IT into your hospital.

Familiarise yourself with each of the separate high quality components that make up an iWOW®. A standard iWOW® is used here to demonstrate.

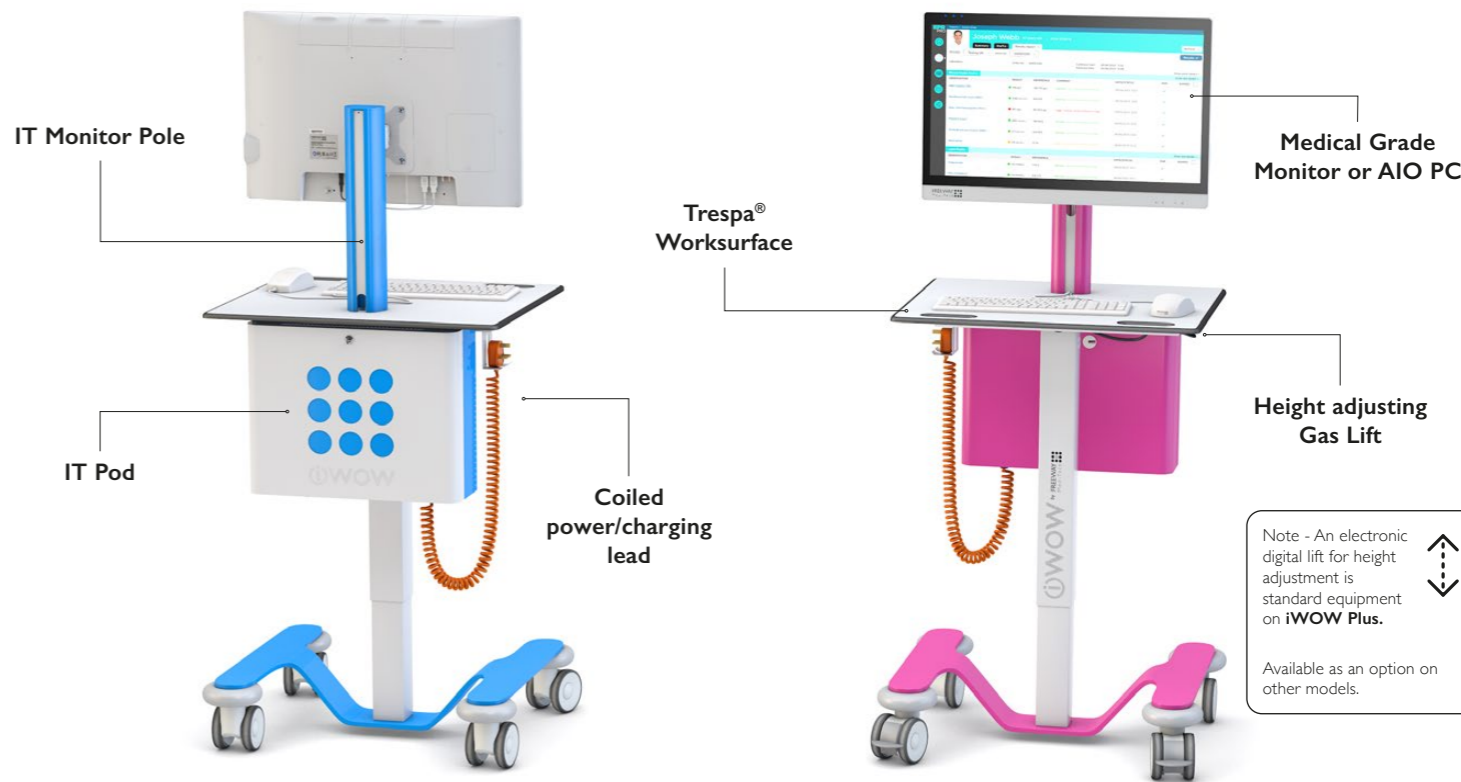
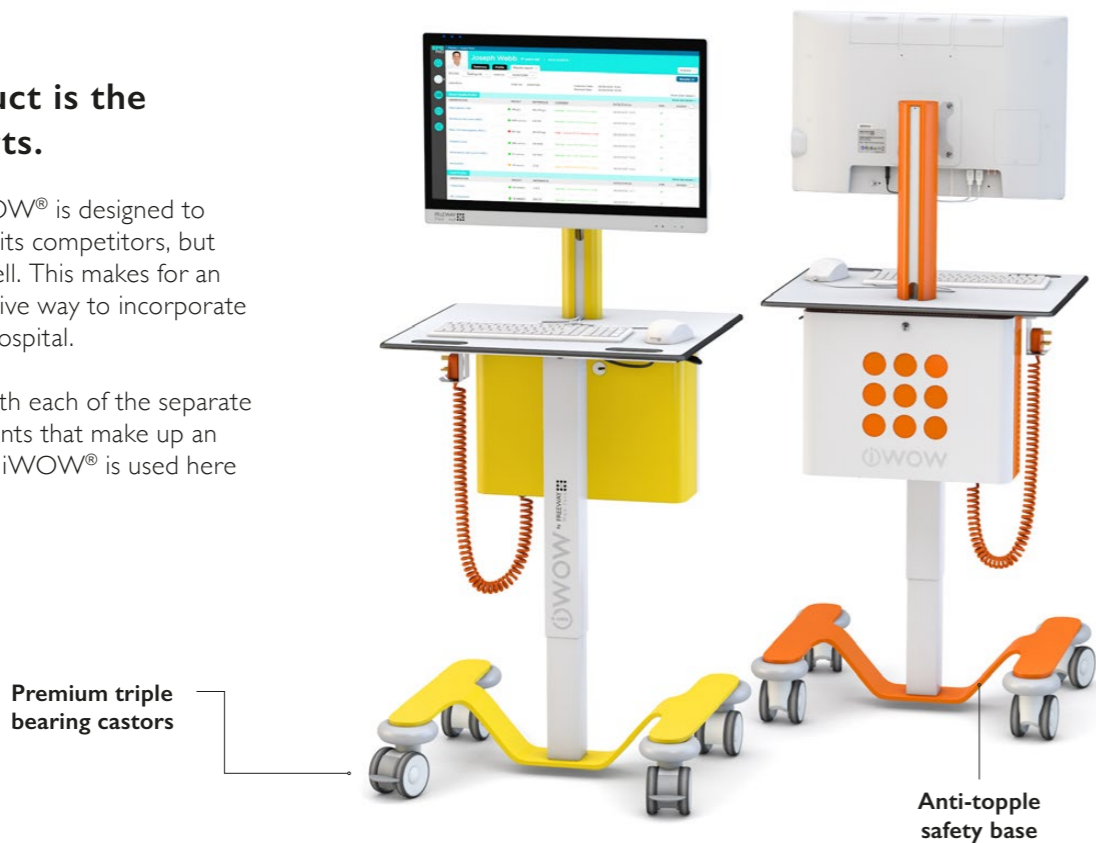

*All iWOWs shown here feature the Freeway Med-Tech Powered Monitor (other options available).

CALL US NOW FOR MORE INFO ON 01635 866717 OR EMAIL SALES@FREEWAYMEDTECH.COM

FREEWAYMEDTECH.COM 7

THE POD

At the centre of all our iWOWs.

Sturdy, easy to clean and secure. The iWOW® Pod is at the core of all the models and houses power connections, transformers, wiring and even a micro PC on the iWOW® DC model (pictured here).

Made from aluminium and coated in nylon modified polyester, the Pod is easy to keep clean using common anti-bacterial chemicals and it's contents are kept secure with a lock and key. Integrated vents ensure any electrical equipment doesn't overheat.



Lockable door - conceals all power and IT equipment including loose wiring/ cables away from dirt and dust.

Charging/power cable - with a reach of approx. 3.5m, the brightly coloured coiled cable ensures the iWOW is never far away from a point to charge or power the cart. Fitted with a pre-wired plug.



Cabling entry/exit - all cabling exits neatly out from the top and rear of the Pod. Each aperture in the aluminium body is protected by a grommet.

Pod rear - constructed from nylon coated aluminium, the main body of the Pod keeps everything protected and secure.

IT, power and wiring - all electronics are housed here, including transformer, cables, Thin Client PC and additional plug sockets (depending on model).

Security - a cam lock and key ensures the Pod contents are kept safe and secure.

Ventilation - thoughtfully placed vents remove any unwanted heat build-up within the Pod.

*Pod shown is from the iWOW model.

THE iWOW[®] MONITOR POLE

Beautifully simple.

By avoiding the need for many complicated moving or adjustable parts, the Monitor Pole is another reliable component in the make up of our iWOWs. Easy up-and-down tilting allow the screen to be viewed from an endless array of positions.

Easy tilt adjustment - monitors can easily be angled to suit different users by simply rotating the monitor itself. The mounting is an industry standard 100x100mm VESA bracket.

A solid foundation - neatly housing untidy cabling from PC to monitor, the main tube is manufactured from extruded aluminium which is anodised and nylon coated for added protection. No more wobbly screens!

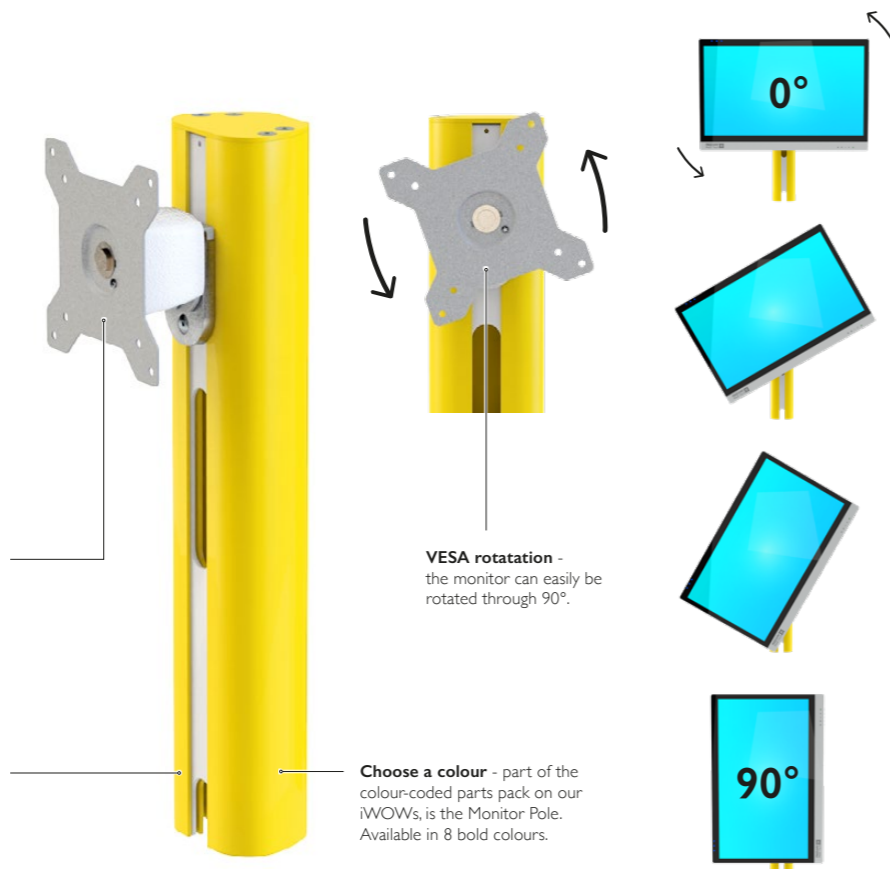

VESA rotation - the monitor can easily be rotated through 90°.

Choose a colour - part of the colour-coded parts pack on our iWOWs, is the Monitor Pole. Available in 8 bold colours.



Neat and tidy cabling

The integral cable routing through the main tube ensures the worksurface remains less cluttered and easier to clean.

It's a win win.



GAS HEIGHT ADJUSTMENT

Squeeze to go higher.

Standard equipment on iWOW® and iWOW® Keyboard, the lever-operated gas lift enables quick and easy height adjustment. All the heavy lifting is done for you on the way up and just a gentle amount of pressure is needed to lower the worksurface.

Maximum vertical travel:

395mm

*Diagrams shown here:
iWOW Keyboard.

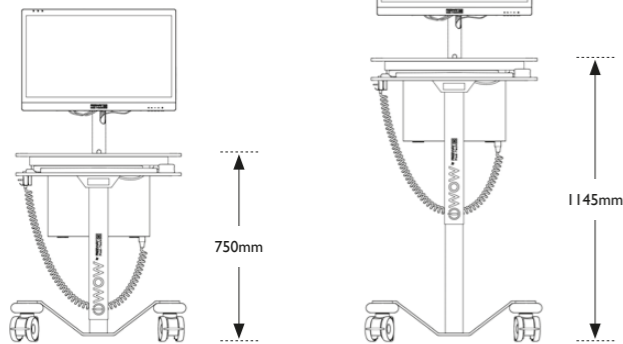

ALL-ELECTRIC LIFT

On iWOW® Plus, it's all electric.

With the extra weight of storage drawers and rail-mounted accessories, on iWOW® Plus the height adjustment is handled seamlessly by a touch button electric lift system. Easy, eh?

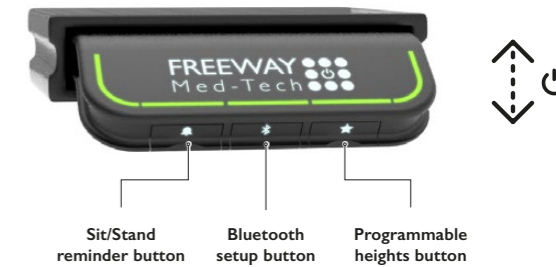

Digital height display - the up/down lever shows the floor-to-worktop distance when raising or lowering the cart (in cm).



THE ANTI-TOPPLE SAFETY BASE

In a busy healthcare environment, we appreciate it can get quite manic. So accidents with equipment are really not wanted.

The 'Heavyweight' - constructed from solid steel and nylon coated for protection, the iWOW base helps keep everything planted to the floor whilst moving the cart is smooth and precise.

Bumpers - built-in protection from those harsh collisions with doors, corridors and furniture.

Ultra low centre of gravity - the deep drop from the top of the castor mounts gives our iWOW base it's 'anti-topple' safety characteristic. Simple, but very effective!

ULTRA DURABLE CASTORS

Using the highest quality components to ensure the smoothest possible movement of our iWOWs.



Large wheels - utilising 100mm diameter wheels reduces vibration and makes going over general lumps and bumps a lot easier compared with a smaller wheel.

Great tyres. Great ride - these soft, grippy and durable tyres are the iWOW's only point of contact with the floor, which is why they are made using the very best high performance material.

Bump protection
4 bumpers included on all iWOWs.



Silky smooth operation
The iWOW's premium castor uses a triple bearing setup so side-to-side movement is as smooth as spinning the wheels.



High performance brakes
Our iWOW's feature 2 castors with integral foot brakes to ensure the cart doesn't stray across a corridor or ward accidentally!

TRESPA® WORKSURFACES

Incredibly tough. No compromises.

A high performance, ultra durable material suited perfectly to the medical environment due to being able to withstand aggressive chemical cleaning week-in, week-out.

The material is so rigid we can comfortably produce worktops with large overhangs and machined handles close to the edge, without any fear of weakness or damage occurring whilst in use.

Material thickness:

10mm

Soft radius corners - because of the material's solid construction, it allows us to machine cut the corners with beautiful rounded edges and corners to remove any 'sharp' contact points.

Extremely rigid - even at only 10mm thick, Trespa® remains incredibly strong allowing us to use it on relatively narrow worksurfaces without any structural issues.



ADJUSTABLE SHELF / WRIST SUPPORT

Ergonomically designed for standing use and users of all different heights.

We've designed our pull-out keyboard shelf to tilt away from the user which greatly reduces the strain on the wrists, helping to reduce the risk of repetitive strain injuries. Especially helpful for taller operatives.

Negative tilt amount:

10°



*Model shown: WOW® Life (Keyboard).

Left handed. Right handed. It doesn't matter.

Simply push the soft rubber wrist support to the desired side until it clicks into place. Simple, eh?



DRAWERS, TRAYS AND DIVIDERS

Trays for speedy re-stocking.

Available in a variety of depths, our removable tray system ensures quick transfer/replacement whilst being easy to clean when separated from the drawer.

Double-height face plate allows for deeper clear trays

Durable, all-metal drawers.

All drawers from our iWOW® Plus and Fixed models are constructed from nylon-coated mild steel and have a detachable face plate which make replacing damaged drawer fronts a simple, end-user operation.



DURABLE COATINGS

Colour. Protection. Long life.

All of our mild steel components and tubing are nylon coated to give a long lasting durable finish. Certain parts are also colour-coded using one of eight vibrant hues so you can match your equipment to a ward or specific treatment areas.

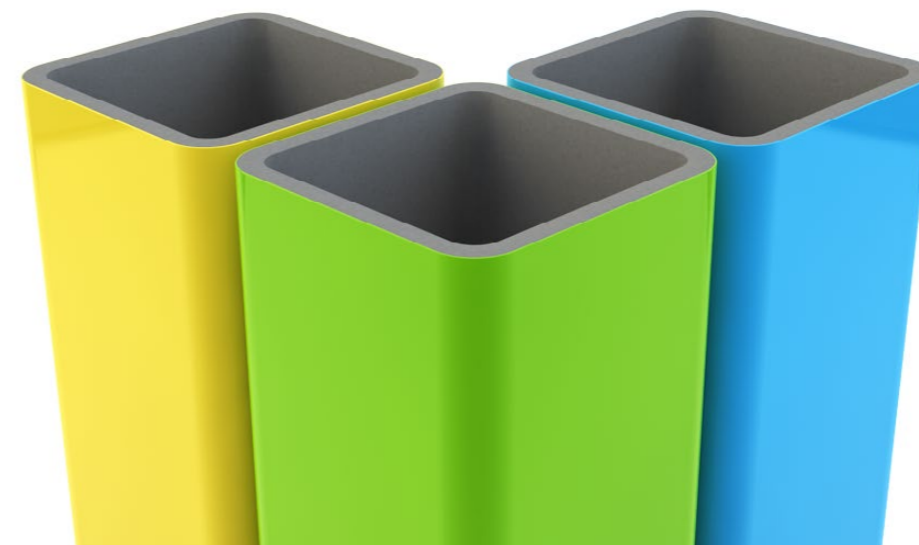

Disinfection made easy

Our nylon coating is able to withstand regular cleaning with alcohol wipes and common industry cleaning products*.



Choose a colour

At no extra cost, you can choose to colour-code your family of iWOWs!



*Refer to pages 228/9 for more details on suitable chemicals/products.

LOOKING FOR SOME COLOUR?

Take your pick.

Go bold or go traditional: the choice is yours and is included as standard on all of our products.

From aqua and lime to pink to orange, any of our equipment can be personalised at your request. Colour coding is a popular way to distinguish which equipment belongs to each ward, so if it is moved, it is instantly recognisable.

All colours are durable so whatever you choose is guaranteed to last.



EASY CHARGING

Just one plug.

Charging your iWOW® couldn't be simpler. Just unhook the high visibility power lead from underneath the worksurface and plug into a regular 240V mains socket. Easy, eh?

3.5 metres

Long-reach flexi cable

All iWOW® models feature a coiled power lead with approx. 3.5m of reach. Note this can be used for a permanent power supply if a mains monitor is opted for.

CUSTOM LENGTHS AVAILABLE

CHARGER DOCK

Convenient off-cart battery charging

For true non-stop performance, fresh batteries can be charged off-cart ready to swap out in a matter of seconds! This enables the iWOW® to stay completely off grid and independent from fixed location mains power sockets.

Note - Charging dock(s) are available separately.



Long-life battery technology

The AIO DC Powered Monitor/PC uses Freeway Med-Tech MT202 Li-ion rechargeable batteries. Rated at DC10.9V 7800mAh - 85Wh.

STANDARD ACCESSORIES

A hook-over system for the Plus and Fixed iWOWs.

Transform your cart by adding a number of accessory modules to the medical rails that come pre-installed on our Plus and Fixed iWOW models.

The addition of a sharps bin or alcohol gel holder really does make the iWOW a more complete workstation on wheels!

There's plenty to choose from

See pages overleaf for our standard hook-over range.



CUSTOM ACCESSORIES

We're happy to design bespoke accessory solutions. Just ask!

The standard iWOW and iWOW Keyboard do not feature pre-installed medical rails, but that doesn't mean they can't feature important accessories if your requirement dictates this.

See examples to the right of bespoke accessories and attachments.



Avoid roll-out delays with pre-installed equipment

We will pre-install hand-held printers and/or similar medical equipment, even if the customer supplies the product. Anecdotally, it saves time and potential errors!



STANDARD ACCESSORIES - iWOW® PLUS / FIXED

Transform an iWOW® Plus or iWOW® Fixed by adding accessories!

IMAGE	PRODUCT CODE	PRODUCT NAME	DESCRIPTION	DIMENSIONS (HXWXD)
1	FW9056	Clinell wipes dispenser	Holds 1 pack of Clinell anti-bacterial wipes	180x260x110mm
2	FW9054	Gel dispenser holder	Holds a push-pump gel dispenser bottle (not included)	165x80x115mm
3	FW9061	O2/Cylinder holder	Designed to suit the Euro CD size cylinders	330x110x150mm
4	FW9053	Catheter holder	An easy clean hook-over unit to house catheter stock	410x100x115mm
5	FW9055	Sharps safe disposal	Hook-over attachment for Sharps bin (not included)	185x65x75mm
6	FW9058	IV pole holder	IV pole attachment only (12.5mm poles sold separately)	90x30x90mm
7	FW9059	IV pole holder & pole	IV pole attachment including 12.5mm stainless steel 2-hook pole	1040x305x90mm
8	FW9057	A4 notes box	An easy clean notes holder for A4 sized folders and binders	270x480x90mm
9	FW9050A	Single glove dispenser	Hook-over dispenser which holds 1 glove pack	330x135x90mm
10	FW9050B	Twin glove dispenser	Hook-over dispenser which holds 2 separate glove packs	330x255x90mm
11	FW9050	Triple glove dispenser	Hook-over dispenser which holds 3 separate glove packs	330x375x90mm
12	FW9051	Apron roll dispenser	Holds a single apron roll (max dia. 145mm)	215x375x160mm



The pre-installed medical rails on all iWOW Plus and Fixed carts.



MEDICAL MONITOR OPTIONS

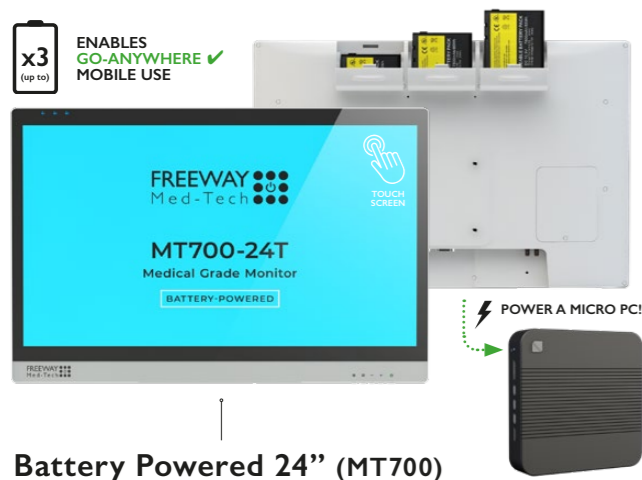

Battery Powered 24" (MT700)

Freeway Med-Tech Battery Powered Medical Monitor

This model is powered by up to 3 Lithium-ion rechargeable battery packs which not only powers itself, but can also power a separate micro form PC and USB accessories. It also features the latest capacitive-type, 10 point multi-touch screen technology. Plus all the standard medical-grade features like high rated dust and moisture ingress protection.



Mains powered 24" (MT600)

Freeway Med-Tech Mains Powered Medical Monitor

For use where an iWOW has a permanent mains electricity supply close by and is to be used in conjunction with a standalone PC. It has the same medical grade features as the MT700 model as well as the same capacitive-type touch screen panel.

All of our AIO/monitors are quality assured - IEC / EN 60601-1 4th edition / CE / WEEE / RoHS Compliant*
For assured safety and quality in the medical environment.



MEDICAL AIO OPTIONS



AIO Battery Powered 20, 22 & 24" (MT500)

Freeway Med-Tech all-in-one (AIO) Battery Powered Medical PC

With the PC built into the screen, this model does not need to have a standalone computer in the Pod or even a mains power supply, as it utilises Lithium-ion rechargeable battery packs to operate whilst completely mobile. Features the latest capacitive-type, 10 point multi-touch screen technology, plus all the standard medical-grade features like high rated dust and moisture ingress protection as standard. New 20" model now available.



AIO Mains powered 24 & 27" (MT400)

Freeway Med-Tech all-in-one (AIO) Mains Powered Medical PC

For use where an iWOW has a permanent mains electricity supply close by and can remain plugged-in whilst in use. With the PC built into the screen, there's no need to have a standalone computer. It has the same medical grade features as the MT500 model as well as the same capacitive-type touch screen panel. New 27" model now available.

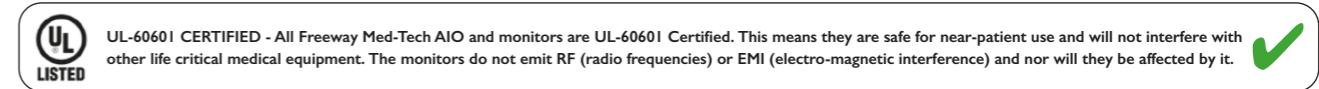

*More details available on request.

WHY BUY FREEWAY? BECAUSE ALL OF

THESE FEATURES ARE STANDARD!



Mobile power + DC out

Our powered monitor and AIO feature DC power out which means they can run a micro-form PC or peripherals and stay mobile for an entire shift.



An ultra smooth ride

Large triple bearing castors provide effortless manoeuvrability and the super soft tyres grip the floor in all conditions. Easy-use foot brakes ensure the iWOW® stays where it was put.



Digital electric lift

All height adjustable models have an electric lift option which is programmable for different user heights and features a digital display showing the exact height of the worktop to the floor.



Clever storage options

The generic metal drawer with tray inset offers great re-stocking and cleaning opportunities by nature of the tray being easily removed. For organisation, a set of sliding divider trays hang at the top of the tray.



Concealed cables

Safety and cleaning are improved by having all loose cabling routed through the IT Monitor Pole from monitor to PC and vice versa. Mouse and keyboard cables also enter the pole via their own dedicated cutout.



Customisable

A service which is quite unique to Freeway, is customisation. We endeavour to deliver products that satisfy the customer's needs, even if that includes fabricating bespoke components and solutions.



iWOW®

INTELLIGENT WORKSTATION ON WHEELS

NOW
AVAILABLE

iWOW-LiFe
A SUPERIOR MOBILE AC POWER OPTION

Ask about it today!

THE iWOW® COLLECTION

An iWOW® for every purpose.

The ever-expanding iWOW® line-up caters for both budget and application needs. From the original iWOW® through to the brand new tablet docking Duo, each model features an industry-leading 24in battery powered monitor or AIO PC.

The lineup now features the all-new iWOW® Dual - two 24in monitors!

iWOW® LiFe AC option now also available.



iWOW®

Height adjust option:
Pneumatic Lift / Electric Lift



iWOW® KEYBOARD

Height adjust option:
Pneumatic Lift / Electric Lift



iWOW® DUAL

Height adjust option:
Electric Lift



iWOW® PLUS

Height adjust option:
Electric Lift



iWOW® FIXED 600

Height adjust option:
Fixed Height



iWOW® FIXED 800

Height adjust option:
Fixed Height



iWOW® DUO

Height adjust option:
Electric Lift



iWOW®

GAS LIFT / ELECTRIC LIFT

The original iWOW® is a compact mobile workstation which lends itself to dedicated tasks such as logging patient data and drug administration. Available with gas height adjustment or a programmable digital electric lift.

iWOW® - WITH GAS LIFT



WORKTOP
750-1145
HEIGHT

POD/BASE COLOURS (included in price)



Blue Purple Pink Red Orange Yellow Green White

PRODUCT CODE
iWOW® with Gas Lift

Our standard 'intelligent workstation on wheels' features a durable, anti-tilt base upon an ultra smooth set of castors (2 brakes). Generous bumpers help alleviate damage from knocks to doors and furniture. With nearly 400mm of travel, the height adjustable post allows users of all heights to work safely and comfortably. Featured on all iWOWs, the lockable IT Pod houses cables, transformers and a micro form PC (if utilising the popular MT700-24T monitor). Fitted with a manually operated gas lift and 3.5m charging lead.

DIMENSIONS

Height = 750-1145mm* Width = 600mm Depth = 510mm

PRODUCT ELEVATIONS

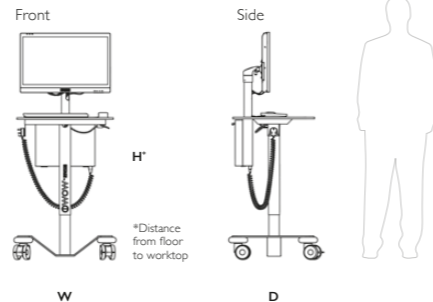

ANTI-TILT BASE & PREMIUM CASTORS



Low centre-of-gravity base features on all iWOW® models

iWOW® - WITH GAS LIFT



POWER FLOW

The monitor's intelligent lithium battery packs, actually power the PC!

The MT700-24T monitor supplied as standard on our iWOWs feature 3 x DC-outputs (12, 15 & 19V) which enable it to not only power a Micro Form Factor PC, but to also power small peripherals like label printers and scanners etc.

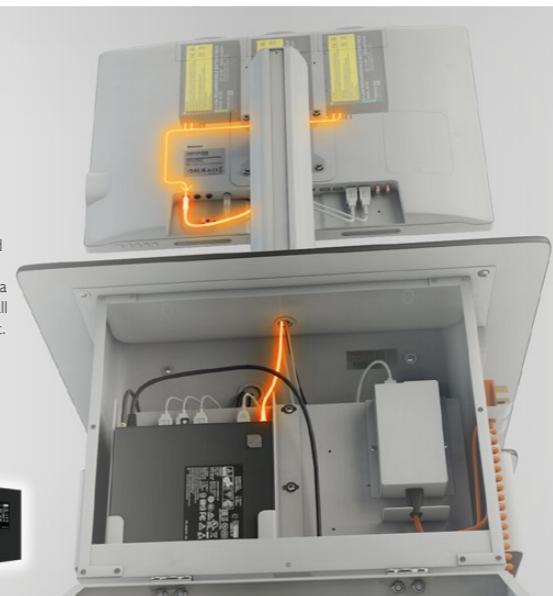
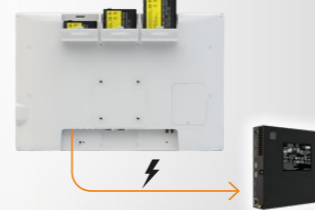

DURABLE WORKSURFACES



Durable Trespa® with integrated handles

LOCKABLE IT POD



(p.8-9)

The key operated lock is standard on all iWOW® IT Pods.

BATTERY POWER MONITOR INCLUDED



(p.120-135)

MICRO FORM PC-READY



Install a micro form PC client into the iWOW® IT Pod.

*PC not included.

GAS-LIFT HEIGHT ADJUSTMENT



(p.12)

Standard equipment on iWOW, the lever-operated gas lift enables quick and easy height adjustment.





WORKTOP
760-1260
HEIGHT

POD/BASE COLOURS *(included in price)*



Blue Purple Pink Red Orange Yellow Green White

PRODUCT CODE

iWOW® with Electric Lift

This model features all the same specification as our standard iWOW®, but it's fitted with a convenient digital electric lift. The height lever is programmable for different user heights and requires only the lightest of touches to activate it, helping even the smallest of operators change the height of the worksurface easily and safely.

DIMENSIONS

Height = 760-1260mm* Width = 600mm Depth = 510mm

PRODUCT ELEVATIONS

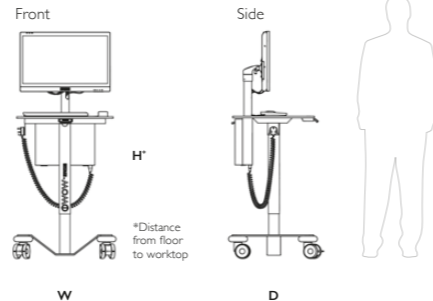

ANTI-TILT BASE & PREMIUM CASTORS



Low centre-of-gravity base features on all iWOW® models



DIGITAL ELECTRIC LIFT

Digital display - lever shows floor-to-worktop height when pressed.



DURABLE WORKSURFACES



Durable Trespa® with integrated handles

LOCKABLE IT POD



(p.8-9)

The key operated lock is standard on all iWOW® IT Pods.

BATTERY POWER MONITOR INCLUDED



(p.120-135)

MICRO FORM PC-READY



Install a micro form PC client into the iWOW® IT Pod.

*PC not included.

CHARGER DOCK *(available separately)*

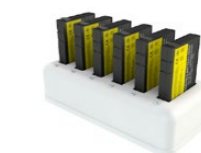

(p.212/13)

Charge up to 6 Li-ion battery packs simultaneously!



iWOW[®] KEYBOARD

GAS LIFT / ELECTRIC LIFT

Based on the original concept, iWOW[®] Keyboard is a compact mobile workstation with additional available worktop space due to a clever slide-out keyboard shelf featuring negative tilt.

Two variations make up the offering - standard gas lift or programmable electric lift.



PRODUCT CODE
iWOW® KEYBOARD with Gas Lift

Featuring a handy space-saving pull-out shelf with movable L/R wrist support, the iWOW Keyboard offers a large uncluttered worksurface to work from. It has the same premium castors, anti-tilt base, IT Pod and IT Monitor Pole as the standard iWOW and also features our MT700-24T Medical Grade Monitor. This model is fitted with the manual gas lift for adjusting the cart's height.

DIMENSIONS
Height = 750-1145mm* Width = 600mm Depth = 520mm

PRODUCT ELEVATIONS

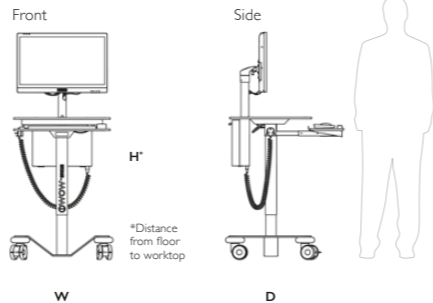

ANTI-TILT BASE & PREMIUM CASTORS



Low centre-of-gravity base features on all iWOW® models (p.14-15)



DURABLE WORKSURFACES



Durable Trespa® with integrated handles (p.16)

LOCKABLE IT POD



The key operated lock is standard on all iWOW® IT Pods. (p.8-9)

BATTERY POWER MONITOR INCLUDED



(p.120-135)

MICRO FORM PC-READY



Install a micro form PC client into the iWOW® IT Pod. *PC not included.

GAS-LIFT HEIGHT ADJUSTMENT



Standard equipment on iWOW, the lever-operated gas lift enables quick and easy height adjustment. (p.12)

POD/BASE COLOURS (included in price)



Blue Purple Pink Red Orange Yellow Green White

iWOW® KEYBOARD - ELECTRIC LIFT



WORKTOP
760-1260
HEIGHT

POD/BASE COLOURS *(included in price)*



Blue Purple Pink Red Orange Yellow Green White

PRODUCT CODE
iWOW® KEYBOARD with Electric Lift

As per the standard iWOW® Electric lift, this Keyboard variant packs all the same specification as its sister gas lift model, but with the added feature of a programmable electric height adjuster making it super convenient for users of all sizes! The digital display shows the exact height from floor to worksurface when pressed so even if it's not programmed to a particular person, they can just remember the height for next time they use the iWOW®.

DIMENSIONS
Height = 760-1260mm* Width = 600mm Depth = 520mm

PRODUCT ELEVATIONS

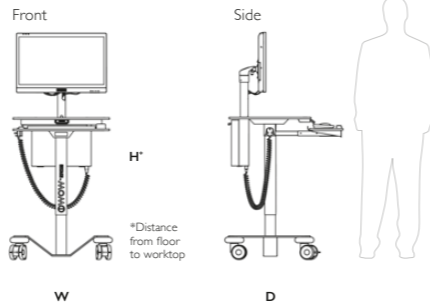

ANTI-TILT BASE & PREMIUM CASTORS



Low centre-of-gravity base features on all iWOW® models

iWOW® KEYBOARD - ELECTRIC LIFT



DURABLE WORKSURFACES



Durable Trespa® with integrated handles

LOCKABLE IT POD



The key operated lock is standard on all iWOW® IT Pods.

BATTERY POWER MONITOR INCLUDED



(p.120-135)

MICRO FORM PC-READY



Install a micro form PC client into the iWOW® IT Pod.

*PC not included.

CHARGER DOCK *(available separately)*



(p.212/3)

Charge up to 6 Li-ion battery packs simultaneously!



iWOW® DUAL

ELECTRIC LIFT

Based on the iWOW® Keyboard, this dual screen variant is a compact mobile workstation which offers vast desktop space in the software environment. Often used for specific tasks which require multiple applications or windows on-screen at once.

The same work surfaces and clever slide-out keyboard shelf featuring negative tilt, come as standard equipment.

Available as electric lift option only.

Now available in 'stacked' configuration for a reduced footprint!

iWOW® DUAL - ELECTRIC LIFT



MONITOR
0° or 90°
ORIENTATION

POD/BASE COLOURS *(included in price)*



Blue Purple Pink Red Orange Yellow Green White

PRODUCT CODE iWOW® DUAL with Electric Lift

When a vast PC desktop is the requirement, iWOW® Dual has it covered. It uses either 2 x MT700 monitors or a combination of 1 x MT700 monitor and 1 x MT500 AIO PC. All can be vertically or horizontally mounted. The monitors can be fully closed together for storing or transport. This model is fitted with the programmable electric lift for adjusting the cart's height.

DIMENSIONS
Height = 820-1270mm* Width = 600mm Depth = 710mm

PRODUCT ELEVATIONS

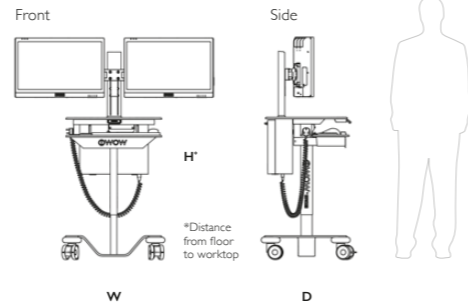

ANTI-TILT BASE & PREMIUM CASTORS



Low centre-of-gravity base features on all iWOW® models *(p.14-15)*

iWOW® DUAL - ELECTRIC LIFT

MONITORS FOLD FLAT FOR STORAGE AND TRANSPORT

Protect the screens when they're not in use by fully folding them together. It also reduces the footprint of the iWOW®.

DIGITAL ELECTRIC LIFT AS STANDARD

Digital display - lever shows floor-to-worktop height when pressed.

DURABLE WORKSURFACES



Durable Trespa® with integrated handles *(p.16)*

LOCKABLE IT POD



The key operated lock is standard on all iWOW® IT Pods. *(p.8-9)*

BATTERY POWER MONITORS INCLUDED



MICRO FORM PC-READY



CHARGER DOCK *(available separately)*



Charge up to 6 Li-ion battery packs simultaneously! *(p.212/13)*

iWOW® DUAL (STACKED) - ELECTRIC LIFT



POD/BASE COLOURS *(included in price)*



Blue Purple Pink Red Orange Yellow Green White

PRODUCT CODE

iWOW® DUAL VERTICAL with Electric Lift

If you need plenty of desktop space, but physical space is an issue, the iWOW® Dual Vertical ticks the boxes. Providing the same desktop space as its side-by-side counterpart, this model features an extended VESA Mount allowing you to stack one monitor above the other, maintaining a tidy work area thanks to the cables being concealed in the mount itself.

DIMENSIONS

Height = 820-1270mm* Width = 600mm Depth = 550mm

PRODUCT ELEVATIONS

Front



W

Side

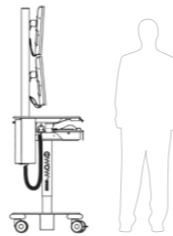

D

H*

*Distance from floor to worktop

ANTI-TILT BASE & PREMIUM CASTORS



(p.14-15)

Low centre-of-gravity base features on all iWOW® models

iWOW® DUAL STACKED - ELECTRIC LIFT

STILL A COMPACT FOOTPRINT!

Due to the 'stacked' nature of the screens, the iWOW® retains one of the most compact footprints on the market for a dual screen 'WoW'.



DIGITAL ELECTRIC LIFT AS STANDARD



Digital display - lever shows floor-to-worktop height when pressed.



DURABLE WORKSURFACES

(p.16)



Durable Trespa® with integrated handles

LOCKABLE IT POD

(p.8-9)



The key operated lock is standard on all iWOW® IT Pods.

BATTERY POWER MONITORS INCLUDED



(p.120-135)

MICRO FORM PC-READY



Install a micro form PC client into the iWOW® IT Pod.

*PC not included.

CHARGER DOCK *(available separately)*



(p.212/3)

Charge up to 6 Li-ion battery packs simultaneously!





iWOW[®] PLUS

1-DRAWER / 4-DRAWER / 5-DRAWER / 8-DRAWER

With electric lift, integral configurable storage, built-in keyboard shelf and accessory rails as standard, the iWOW[®] Plus delivers on a range of different hospital uses.

All drawers are secured via a variety of lock options enabling sensitive drugs and treatments to be held on-cart.

Now available in 4 new integrated storage options.



WORKTOP
760-1260
HEIGHT



PULL-OUT
KEYBOARD
SHELF

POD/BASE/DRAWER COLOURS (included in price)



Blue Purple Pink Red Orange Yellow Green White

PRODUCT CODE
iWOW® PLUS I-Drawer

The iWOW® Plus I-Drawer has the capacity to hold a single storage tray, with the option of 4 different depths. Secured using the same method as the other Plus models, it protects its contents without compromising quality. If you need to store a few odds and ends but don't need multiple drawers, the iWOW® Plus I-Drawer is the budget-conscious choice.

DIMENSIONS
Height = 840-1295mm* Width = 600mm Depth = 670mm

PRODUCT ELEVATIONS

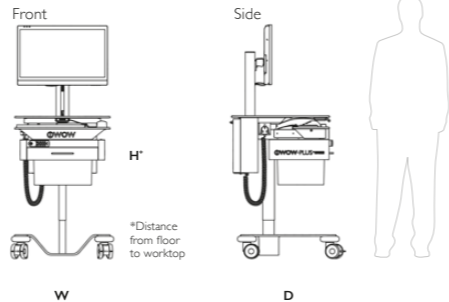

ANTI-TILT BASE & PREMIUM CASTORS



Low centre-of-gravity base features on all iWOW® models

iWOW-PLUS
DRAWER/TRAY
STORAGE SYSTEM

Removable main tray and separate organisers.

The iWOW® Plus' storage can be pre-stocked remotely and swapped out in seconds. It also ensures deep cleans are made easy too!



DURABLE WORKSURFACES



Durable Trespa® with integrated handles

LOCKABLE IT POD



(p.8-9)
The key operated lock is standard on all iWOW® IT Pods.

BATTERY POWER MONITOR INCLUDED



(p.120-135)

MICRO FORM PC-READY



Install a micro form PC client into the iWOW® IT Pod.

*PC not included.

DIGITAL ELECTRIC LIFT (as standard)



(p.13)

Standard equipment on iWOW-Plus, all height adjustment is handled by a programmable electric lever.

iWOW® PLUS - 4 DRAWER



WORKTOP
760-1260
HEIGHT



PULL-OUT
KEYBOARD
SHELF

MEDICAL
RAIL
AS STANDARD

POD/BASE/DRAWER COLOURS (included in price)



Blue Purple Pink Red Orange Yellow Green White

PRODUCT CODE
iWOW® PLUS 4-Drawer

Based upon our original iWOW®, the iWOW® Plus brings in a keyboard shelf and a configurable storage drawer bank. This opens up so many more possibilities for how the cart can be used. The number, size and order of the drawers can all be chosen at time of order. The drawers feature integrated trays and divider compartments so stock can be kept separated and easy to find. See overleaf for options and specification. All other components share the same high quality and durability as our other iWOW® models. Two medical accessory rails are fitted as standard.

DIMENSIONS

Height = 840-1295mm* Width = 635mm Depth = 670mm

PRODUCT ELEVATIONS

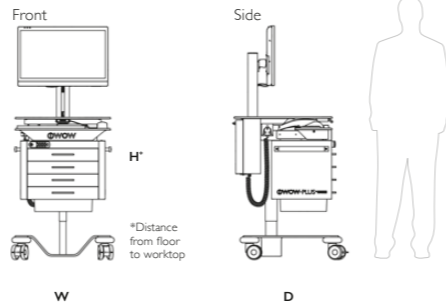

ANTI-TILT BASE & PREMIUM CASTORS



Low centre-of-gravity base features on all iWOW® models

iWOW® PLUS - 5 DRAWER

iWOW-PLUS

4-DRAWER STORAGE CHOICES

Need a specific drawer size or configuration?

With various combinations of drawer depths, drawer order and tray size, there's almost certainly a configuration to suit your needs.

Ask us today for more info!



HOOK-OVER ACCESSORIES (available separately)

(p.24-27)

*Consumables not included.



LOCKABLE IT POD

(p.8-9)



The key operated lock is standard on all iWOW® IT Pods.

CALL US NOW FOR MORE INFO ON 01635 866717 OR EMAIL SALES@FREEWAYMEDTECH.COM

BATTERY POWER MONITOR INCLUDED



(p.120-135)

MICRO FORM PC-READY



Install a micro form PC client into the iWOW® IT Pod.

*PC not included.

DIGITAL ELECTRIC LIFT (as standard)

(p.13)



Standard equipment on iWOW-Plus, all height adjustment is handled by a programmable electric lever.

iWOW® PLUS - 5 DRAWER



WORKTOP
760-1260
HEIGHT



PULL-OUT
KEYBOARD
SHELF



MEDICAL
RAIL
AS STANDARD

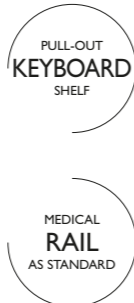

POD/BASE/DRAWER COLOURS (included in price)



Blue Purple Pink Red Orange Yellow Green White

PRODUCT CODE iWOW® PLUS 5-Drawer

Looking for multiple drawers, but the 4-Drawer isn't quite enough? We've thought of that too! The iWOW® Plus 5-Drawer allows for an extra level of storage yet preserves the same overall footprint. The additional tray space allows you to squeeze in the extra consumables you need yet remains easy to clean with a sleek appearance. The best of both worlds! A fantastic option for a versatile ePMA cart.

DIMENSIONS
Height = 920-1295mm* Width = 600mm Depth = 670mm

PRODUCT ELEVATIONS

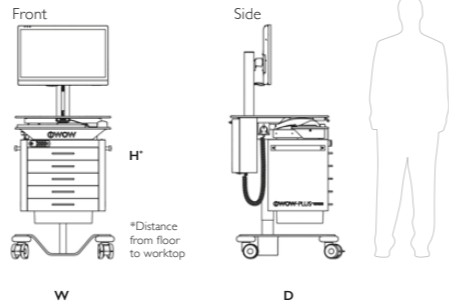

ANTI-TILT BASE & PREMIUM CASTORS



Low centre-of-gravity base features on all iWOW® models

iWOW® PLUS - 5 DRAWER

iWOW-PLUS

5-DRAWER STORAGE CHOICES

Need a specific drawer size or configuration?

With various combinations of drawer depths, drawer order and tray size, there's almost certainly a configuration to suit your needs.

Ask us today for more information!



HOOK-OVER ACCESSORIES (available separately)

(p.24-27)

*Consumables not included.



LOCKABLE IT POD

(p.8-9)



The key operated lock is standard on all iWOW® IT Pods.

BATTERY POWER MONITOR INCLUDED



(p.120-135)

MICRO FORM PC-READY



Install a micro form PC client into the iWOW® IT Pod.

*PC not included.

DIGITAL ELECTRIC LIFT (as standard)

(p.13)



Standard equipment on iWOW-Plus, all height adjustment is handled by a programmable electric lever.

iWOW® PLUS - 8 DRAWER



WORKTOP
760-1260
HEIGHT

PULL-OUT
KEYBOARD
SHELF



POD/BASE/DRAWER COLOURS (included in price)



Blue Purple Pink Red Orange Yellow Green White

PRODUCT CODE
iWOW® PLUS 8-Drawer

Maximum storage, height adjustable. The iWOW® Plus 8-Drawer boasts an incredible amount of storage, with every area being utilised as efficiently as possible, and only a small increase to its footprint. Between the removable trays is an integrated, sub divided, additional storage area to house drugs labels or similar items. Manoeuvrability is not sacrificed, thanks to the large durable castors that come as standard.

DIMENSIONS

Height = 960-1280mm* Width = 805mm Depth = 700mm

PRODUCT ELEVATIONS

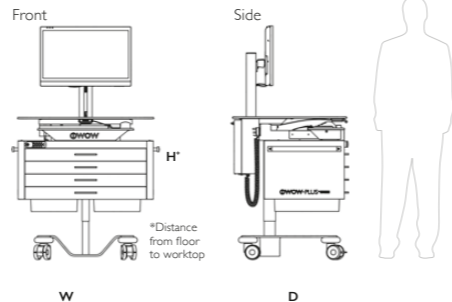

ANTI-TILT BASE & PREMIUM CASTORS



Low centre-of-gravity base features on all iWOW® models

iWOW® PLUS - 8 DRAWER

iWOW-PLUS

THE DUAL TRAY SYSTEM ON THE 8-DRAWER

XL drawers, but the same conveniently sized removable trays and organisers!

Each drawer houses 2 x tray sets that feature on the other Plus models, just rotated 90°.

We feel this is the best solution for increased storage whilst retaining the great portability of our standard trays.

Again, as per other Plus models, the main trays hold smaller organiser trays which slide back and forth and can be lifted out independently.



HOOK-OVER ACCESSORIES (available separately)



(p.24-27)

*Consumables not included.

LOCKABLE IT POD



(p.8-9)

The key operated lock is standard on all iWOW® IT Pods.



BATTERY POWER MONITOR INCLUDED



(p.120-135)

MICRO FORM PC-READY



Install a micro form PC client into the iWOW® IT Pod.

*PC not included.

DIGITAL ELECTRIC LIFT (as standard)



(p.13)

Standard equipment on iWOW-Plus, all height adjustment is handled by a programmable electric level.



iWOW® Plus' storage...

The same drawer/tray system is used across the Plus family.



Sliding organiser trays - practical lift-out divider trays in 5 different compartment styles.

Removable drawer trays - 4 different depths, convenient storage trays for easy cleaning with integral labelling.

All-metal soft-close drawer - a generic chassis with removable faceplate and handle for cost-effective maintenance/repair.



A tray to suit every purpose

The iWOW® Plus' inner-drawer removable storage trays are available in 4 different sizes. All dimensions are consistent apart from each trays height. They all feature the same profile around the top edge which hold the sliding organiser trays and can be kept clean with alcohol wipes.

Length: 425mm
Width: 310mm
Height: 80/160/230/300mm

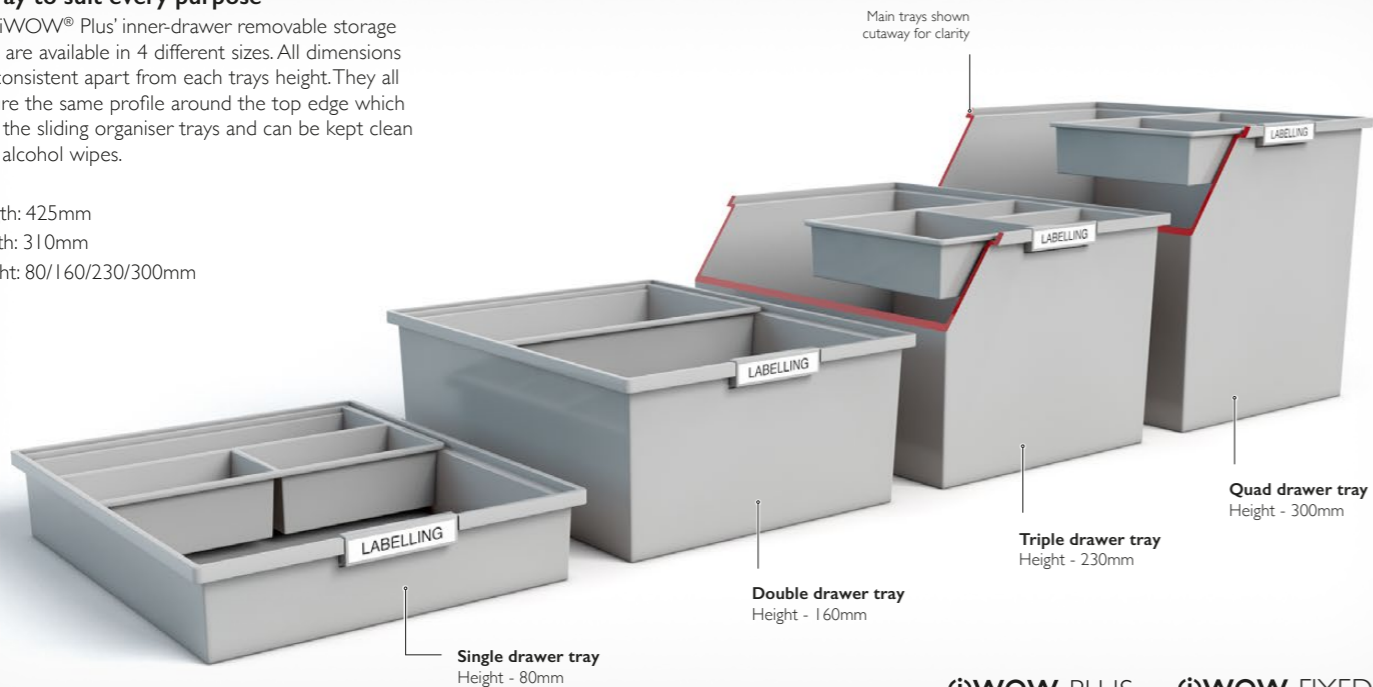

iWOW-PLUS iWOW-FIXED⁶⁰⁰

For objects of all shapes and sizes

The iWOW® Plus' sliding divider trays are available in 5 different variants. All dimensions are consistent for each tray. Again, they are very easy to keep clean by simply wiping over with standard alcohol wipes or similar cleaning solutions.

Length: 286mm
Width: 200mm
Height: 80mm

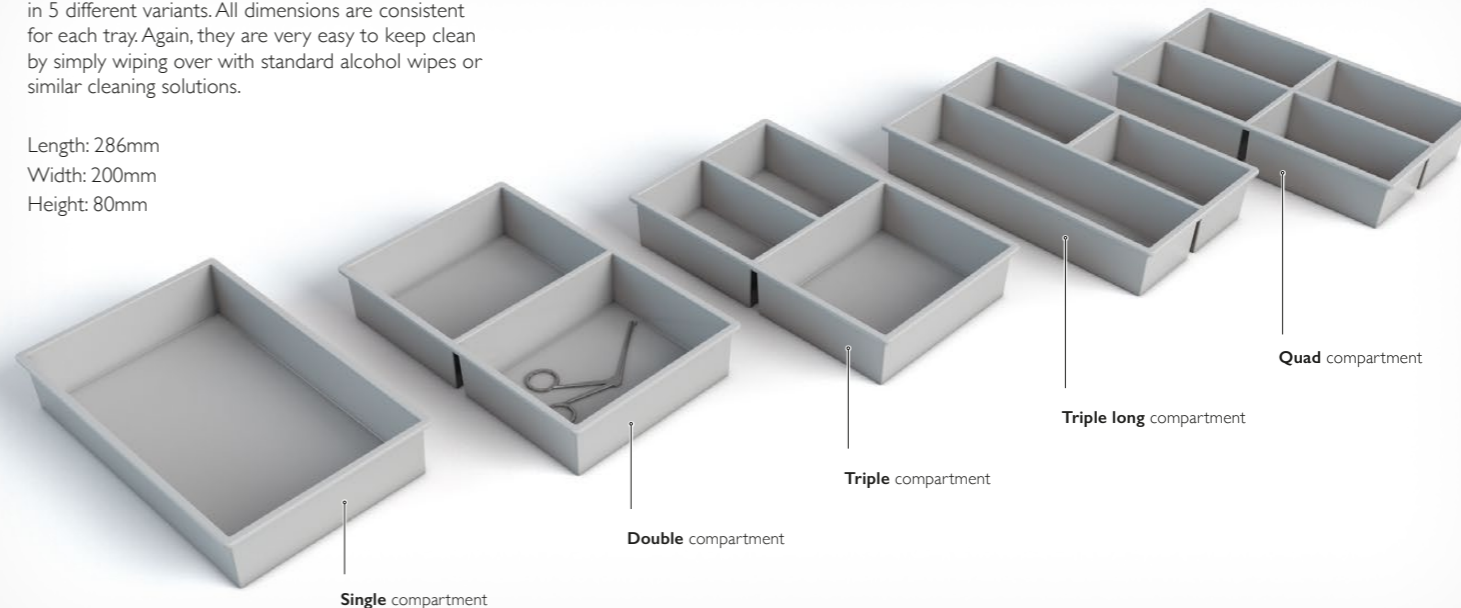

iWOW-PLUS iWOW-FIXED⁶⁰⁰

For those wanting 'keyless' security.

Easy day-to-day PIN operation.

Secure sensitive stock with our keyless operation digital lock. It provides security with a simple 4-digit user-defined PIN code. The device is powered by 2 x AA batteries.



A forgotten code? - there's always a master key to override the digital lock and reset it in the event of forgotten or lost PINs.

Does my security choice affect the cost?

Our digital keyless and Abloy®/DOM® keyed security choices, are no-cost options and included in the base cost of our iWOW Plus workstations.



Or, if you prefer keys then the cam lock is the one for you.

DOM ix Teco 382

This heavy-duty high security lock is supplied in a Bright Nickel Finish, with master keys also available.



Attractive - bright nickel plated finish fits perfectly with other high quality components on the iWOW® Plus workstation.





iWOW® FIXED 600

FIXED-HEIGHT, 600MM WIDE

Now available in two different widths, iWOW® Fixed offers storage a plenty with the iWOW® drawer/tray system plus up to four medical rails for hook-over accessories. All this on a fixed height chassis.

iWOW® FIXED 600 - XL STORAGE / FIXED-HEIGHT / 600MM WIDE



POD/DRAWER COLOURS (included in price)



Blue Purple Pink Red Orange Yellow Green White

PRODUCT CODE
iWOW® FIXED 600

For those not needing height adjustment, this fixed-height model has an abundance of storage space utilising the same drawer/tray system as iWOW® Plus. It also features up to four medical accessory rails which can hold accessories like Sharps bins, gel holders, O₂ holders, notes folders, to name but a few (see pages 26-29). As other models, cables, power supplies and a micro PC can all be safely housed in the integrated iWOW® IT Pod (see pages 10-11).

DIMENSIONS

Height = 1130mm* Width = 600mm Depth = 620mm

PRODUCT ELEVATIONS

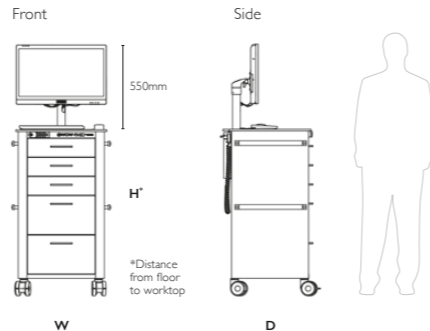

MEDICAL RAILS FOR ACCESSORIES



Accessory rails x4 are standard equipment on iWOW Fixed.

iWOW® FIXED 600 - XL STORAGE / FIXED-HEIGHT / 600MM WIDE

iWOW-FIXED by FREEMWAY Med-Tech

iWOW FIXED 600 SERIES

A fixed-height cart with plenty of storage and accessory space!

- XL capacity storage design
- All-metal storage drawers with replaceable front panels
- Removable trays for easy stocking and re-stocking
- Medical rails x4 for hook-over accessories
- The same durable Trespa® worksurface, as all iWOW® models



DURABLE WORKSURFACES



Durable Trespa® with integrated handles

LOCKABLE IT POD



The key operated lock is standard on all iWOW® IT Pods.

CALL US NOW FOR MORE INFO ON 01635 866717 OR EMAIL SALES@FREEMWAYMEDTECH.COM



BATTERY POWER MONITOR INCLUDED



MICRO FORM PC-READY



Install a micro form PC client into the iWOW® IT Pod.

*PC not included.

HOOK-OVER ACCESSORIES (available separately)



*Consumables not included.



iWOW® FIXED 800

FIXED-HEIGHT, 800MM WIDE

Now available in the popular '800' width, this variant of iWOW® Fixed really delivers on storage capacity. Different to its slimmer cousin, iWOW® Fixed 800 features the HTM71 storage tray standard and therefore is compatible with existing back-room storage units.

iWOW® FIXED 800 - XXL STORAGE / FIXED-HEIGHT / 800MM WIDE



WORKTOP
FIXED
HEIGHT

MEDICAL
RAIL
AS STANDARD

POD/DRAWER COLOURS (included in price)



Blue Purple Pink Red Orange Yellow Green White

PRODUCT CODE
iWOW® FIXED 800

For those needing maximum storage, this fixed-height 800 model has an abundance of storage, utilising the HTM71 600x400mm tray system. These hospital standard trays can be swapped out quickly and easily with new stocked trays from modular storage racks which support the HTM71 system (see pages 64-67). As per other iWOW® models; all cables, power supplies and a micro PC can be safely housed in the integrated iWOW® IT Pod (see pages 10-11).

DIMENSIONS

Height = 1130mm* Width = 800mm Depth = 620mm

PRODUCT ELEVATIONS

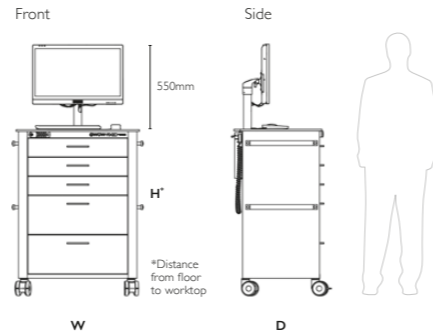

MEDICAL RAILS FOR ACCESSORIES



(p.24-27)

Accessory rails x4 are standard equipment on iWOW Fixed.

iWOW® FIXED 800 - XXL STORAGE / FIXED-HEIGHT / 800MM WIDE

iWOW-FIXED by FREEWAY Med-Tech

Now even more storage space with the iWOW Fixed 800 Series!

- XXL storage capacity
- All-metal 700mm wide storage drawers with replaceable front panels
- HTM71 easy re-stocking interchangeable trays
- Medical rails x4 for hook-over accessories
- The same durable Trespa® worksurface, as all iWOW® models



DURABLE WORKSURFACES

(p.16)



Durable Trespa® with integrated handles

LOCKABLE IT POD

(p.8-9)



The key operated lock is standard on all iWOW® IT Pods.



BATTERY POWER MONITOR INCLUDED



(p.120-135)

MICRO FORM PC-READY



Install a micro form PC client into the iWOW® IT Pod.

*PC not included.

HOOK-OVER ACCESSORIES (available separately)

(p.24-27)

*Consumables not included.



Manage the iWOW® Fixed 800 re-stocking process in a flash!

With pre-stocked trays held ready in a separate, colour matched cart, it's so easy and quick to swap used trays for new. The tall HTM71 storage units can be colour matched to your iWOW® Fixed 800 so the user can locate its stock without a fuss.

PRE-STOCKED TRAY
(in storage unit)



LOW / EMPTY TRAY
(from iWOW Fixed 800)

Colour identifiable HTM71 storage units - fully stocked trays are held here ready for quick re-stocking of an iWOW® Fixed 800 matching its colour.



Colour coded back-room storage.

By each iWOW having its own corresponding colour storage unit, the whole process of re-stocking in different departments is easy and better logged.

Freeway HTM71 - a colour-coded organised re-stocking system.

Another way to use the HTM71 system, is to keep pre-stock trays in the 'green' area of the tall storage and put empty trays back into the 'red' area. This simple, effective stock storage system can be utilised with the iWOW® 800 cart.



HTM71 trays (Health Technical Memorandum 71)

Published by the NHS, the HTM71 standard is a consistent sized storage solution for trays, baskets and cupboards which all accept these standardised 600x400mm trays.

**GREEN AREA
=
STOCKED TRAYS**

**RED AREA
=
EMPTY TRAYS**



Create unparalleled speed and organisation when re-stocking carts

- Empty tray out and put into the red area
- A new, fully stocked tray pulled from the green area and put into the iWOW®
- Back-room staff then stock the empty trays and rotate into the green area of the tall storage unit.

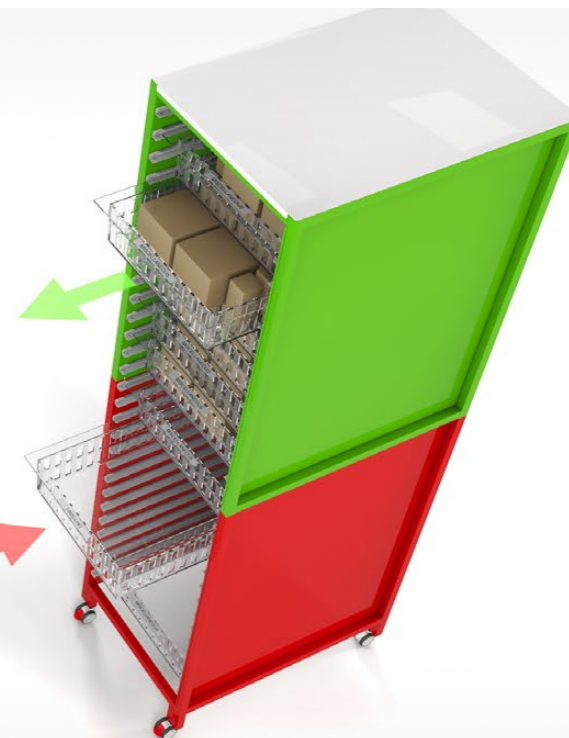



iWOW[®] DUO

ELECTRIC LIFT

A dual-use mobile workstation offering the flexibility of a removable tablet PC that can be docked into the iWOW[®] Duo whilst powered up and in use, enabling the user to continue working using the main monitor, keyboard and mouse.

Programmable electric lift and a lockable tablet housing is standard equipment on the iWOW[®] Duo.

So, how is it used?

Just one of the benefits of using iWOW-Duo, is great infection control. By removing just the tablet to enter sensitive areas, it means that on exit, only the tablet requires sanitisation!

Instantly live

Once the tablet is removed from the security clamp, it near instantaneously shuts down the cart's screen and wakes its own display.

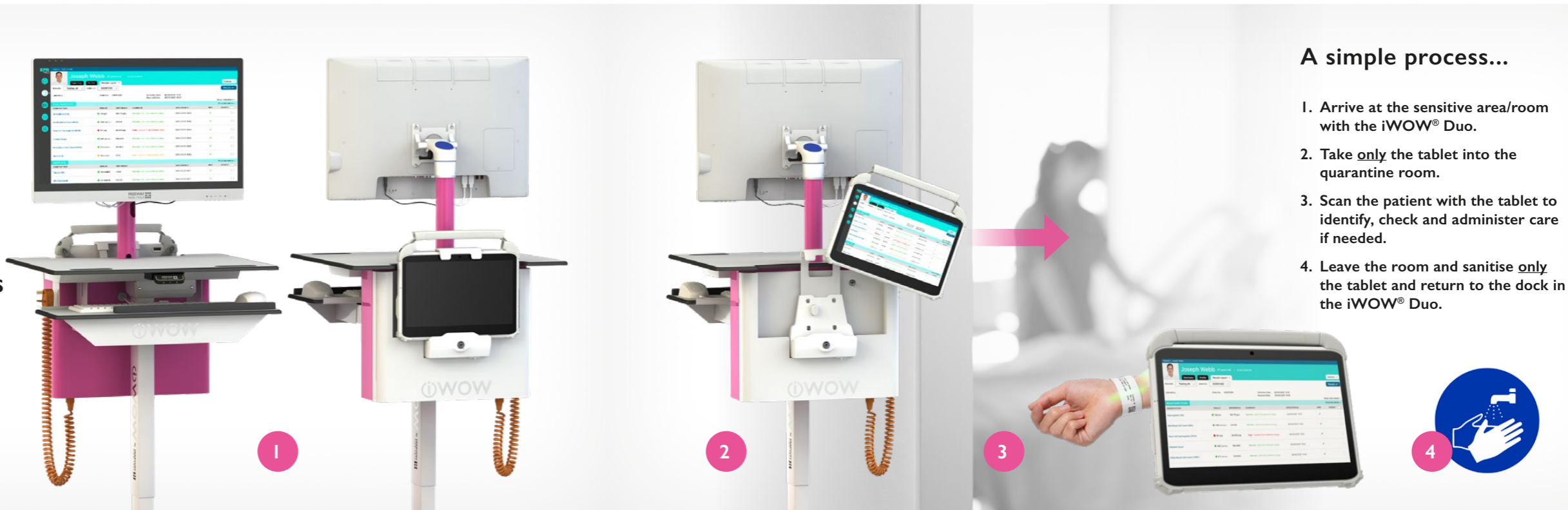

A simple process...

1. Arrive at the sensitive area/room with the iWOW® Duo.
2. Take only the tablet into the quarantine room.
3. Scan the patient with the tablet to identify, check and administer care if needed.
4. Leave the room and sanitise only the tablet and return to the dock in the iWOW® Duo.

iWOW® DUO - TABLET PC DOCK / WORKSTATION



WORKTOP
760-1260
HEIGHT

PULL-OUT
KEYBOARD
SHELF



LOCKABLE
DOCKING
CLAMP

POD/BASE COLOURS *(included in price)*



Blue Purple Pink Red Orange Yellow Green White

PRODUCT CODE
iWOW® DUO

The iWOW® Duo really does offer flexible mobile computing. It's powerful removable tablet PC which can run both Windows® 10 or 11 and enables the user to take work away whilst on breaks and return then continue without interruption. The tablet can be left on the cart without fear of it going missing due to the lockable clamp housing. Also featuring the popular pull-out negative tilt keyboard shelf. All other components share the same high quality and durability as our other iWOW® models in the range.

DIMENSIONS

Height = 760-1260mm* Width = 600mm Depth = 620mm

PRODUCT ELEVATIONS

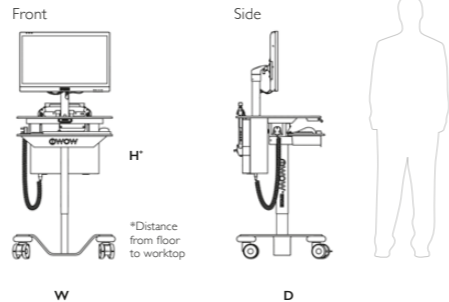

ANTI-TILT BASE & PREMIUM CASTORS



Low centre-of-gravity base features on all iWOW® models

iWOW® DUO - TABLET PC DOCK / WORKSTATION

iWOW-DUO by FREEMWAY Med-Tech

Experience zero screen downtime when docking the tablet!

As the tablet is docked into the Duo's security clamp, the tablet's screen is immediately switched off and the cart's main 24in medical monitor becomes live. This hot-swappable process means whatever application you were using on the tablet, stays open and is shown on the main monitor without delay.

Tablet docked: main screen switches on.



DURABLE WORKSURFACES

(p.16)



Durable Trespa® with integrated handles



Undocking the tablet instantly restores power to its screen and switches off the cart screen.

LOCKABLE TABLET CLAMP



A key operated lock on the tablet dock offers enhanced security from theft.

BATTERY POWER MONITOR INCLUDED



(p.120-135)

TABLET & ACCESSORIES INFO



See pages 196-207 For detailed information on the MT300 Tablet and available accessories.

DIGITAL ELECTRIC LIFT *(as standard)*



(p.13)

Standard equipment on iWOW® Duo, all height adjustment is handled by a programmable electric level.





CUSTOM WORKSTATIONS

MOBILE IT SOLUTIONS

Configurable, versatile, capable. Our range of Custom Workstations can be modified to suit a vast range of individual requirements, featuring both a removable chart board and current IT technology, if you so wish!

Ergonomic computer arms work in harmony with a classic paper-based facility - the perfect option for transitioning to electronic records and charting.

Secure IT

Featuring our full and half height, lockable IT Pods which house the electricals, wiring and of course, the PC.

Plenty of space

The Pod's have space for a MFF PC and an ethernet connection at the rear/base.



*Mains powered IT pod shown above.

Keyless lock.

IT equipment is kept safe and secure via the digital keyless lock.

Easy clean surfaces...

Our nylon coating withstands regular cleaning with alcohol wipes and common industry cleaning products*.

*Refer to pages 228/9 for more details on suitable chemicals/products.

The Ergotron StyleView Sit / Stand Arm

The Ergotron StyleView Sit/Stand IT Arm is an invaluable addition to our Custom Workstations. It boasts ergonomic adjustments whilst retaining a clean, clinical appearance and has been designed to incorporate many features to make lives easier, such as hidden cable routing, integrated built-in mouse storage and the option to easily adjust it to any position.



The Ergotron StyleView arm shown on our single column Custom ITU Workstation.



Fully adjustable.

*Keyboard and mouse not included. Freeway Medical powered monitor shown. Other monitors are compatible.



Foldable.

Comfortable, however it's used.

With its generous range of movement, the Ergotron arm can adapt to fit the many 'comfort' zones demanded by the varying heights of different users.



CUSTOM WORKSTATION - SINGLE COLUMN



SIT
IT-ARM
STAND

MEDICAL
RAIL
AS STANDARD

DRAWER COLOURS *(included in price)*



Blue Purple Pink Red Orange Yellow Green White

PRODUCT CODE

CUSTOM WORKSTATION - Single column

Comprising of a single bank of soft-close drawers, with an optional single point locking system as well as the Freeway IT Pod, this cart can cater for a wide range of requirements. The size, colour and even type of the drawers can be moulded to your specific use case, whether it be HTM71 trays you need or classic steel drawers. Conceal your Micro PC, cabling and plug sockets within the IT Pod, leaving only the Monitor, keyboard and mouse conveniently attached to the arm.

DIMENSIONS

Height = 945mm Width = 925mm Depth = 510mm

PRODUCT ELEVATIONS

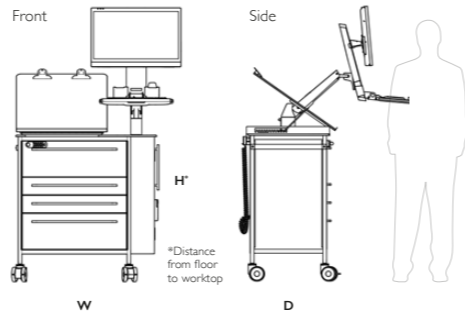

ADJUSTABLE CHART BOARD *(as standard)*

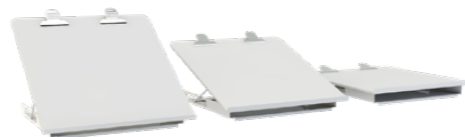

CUSTOM WORKSTATION - SINGLE COLUMN

The sit-stand Ergotron IT arm

- Rotates, tilts, raises and lowers to suit virtually any user height.
- Can be worked at, either stood up or sat down.
- Universal mouse tray pulls out from either side.

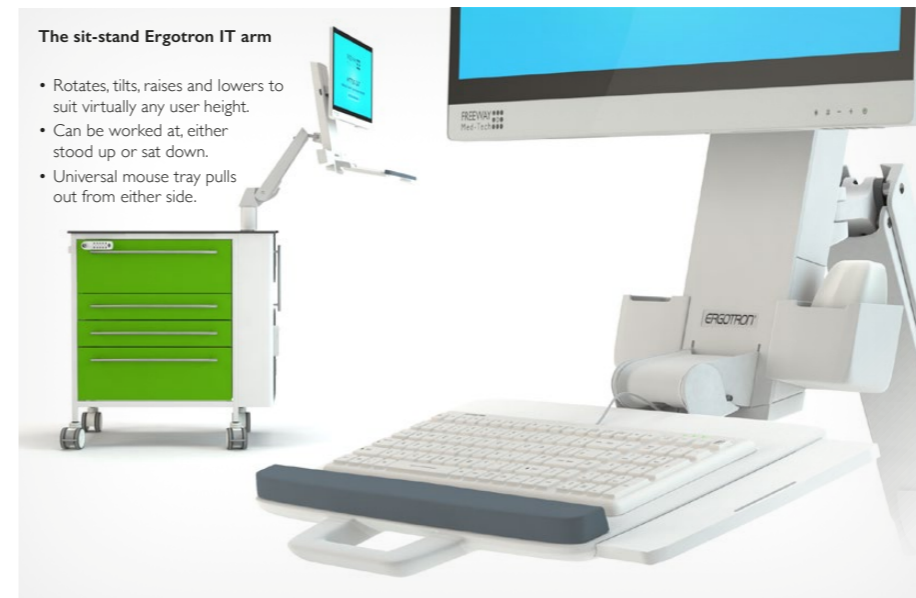

SLIDE-ON/OFF CHART BOARD



DURABLE TRESPA® WORKSURFACE



CALL US NOW FOR MORE INFO ON 01635 866717 OR EMAIL SALES@FREEWAYMEDTECH.COM



BATTERY POWER MONITOR INCLUDED



(p.120-135)

HTM71 STANDARDISED TRAY SYSTEM



See pages 78-81
For more information on the HTM71 Fast-Stock system.

HOOK-OVER ACCESSORIES *(available separately)*

(p.24-27)

*Consumables not included.



FREEWAYMEDTECH.COM 95

CUSTOM WORKSTATION - DOUBLE COLUMN



SIT
IT-ARM
STAND

MEDICAL
RAIL
AS STANDARD

DRAWER COLOURS *(included in price)*



Blue Purple Pink Red Orange Yellow Green White

PRODUCT CODE CUSTOM WORKSTATION - Double column

Like the Single Column variant, there is an option for HTM71 or steel drawers, or both! The addition of an extra storage column opens even more possibilities, allowing greater capabilities of tailoring the cart to your needs. If you need a large amount of storage as well as extra work space, you can specify a handy pull-out shelf, or if you require individual split locking drawers, we have a solution for that too! The adjustment from paper to electronic charting can be a challenge, but our custom workstation makes it easy, combining both elements to streamline the changeover.

DIMENSIONS
Height = 945mm* Width = 1625mm Depth = 510mm

PRODUCT ELEVATIONS

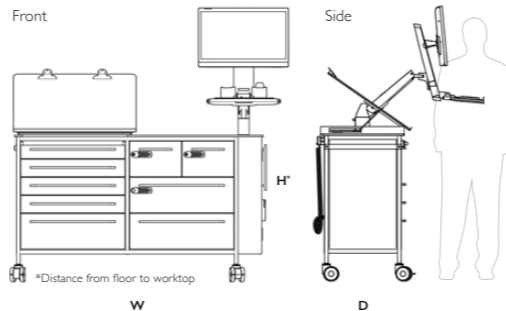

ADJUSTABLE CHART BOARD *(as standard)*



CUSTOM WORKSTATION - DOUBLE COLUMN

Integrated pull-out shelf

With a high quality stainless steel skin. Soft-close mechanism fitted, including drawers.



HTM71 storage

Standardised HTM71 tray system fitted to all wide drawers.

Locking drawers

Central locking option, or selected drawers can be fitted with digital keyless lock (override key available for forgotten PIN).

SLIDE-ON/OFF CHART BOARD



DURABLE TRESPA® WORKSURFACE



CALL US NOW FOR MORE INFO ON 01635 866717 OR EMAIL SALES@FREEWAYMEDTECH.COM



BATTERY POWER MONITOR INCLUDED



(p.120-135)

HTM71 STANDARDISED TRAY SYSTEM



See pages 78-81

For more information on the HTM71 Fast-Stock system.

HOOK-OVER ACCESSORIES *(available separately)*

(p.24-27)

*Consumables not included.



FREEWAYMEDTECH.COM 97

NEW

iWOW® LiFe

A 220V AC POWER OPTION

Introducing iWOW® LiFe, our brand new option for 'on-the-go' AC power. Utilise all your existing monitors and IT equipment!

Available now on selected
iWOW® models.



iWOW-LiFe

by FREWAY
Med-Tech

iWOW® LiFe - A BRIEF TOUR

Take a look around an iWOW® LiFe 'Keyboard' model.



Other colours available!



iWOW® LiFe - POWER FLOW

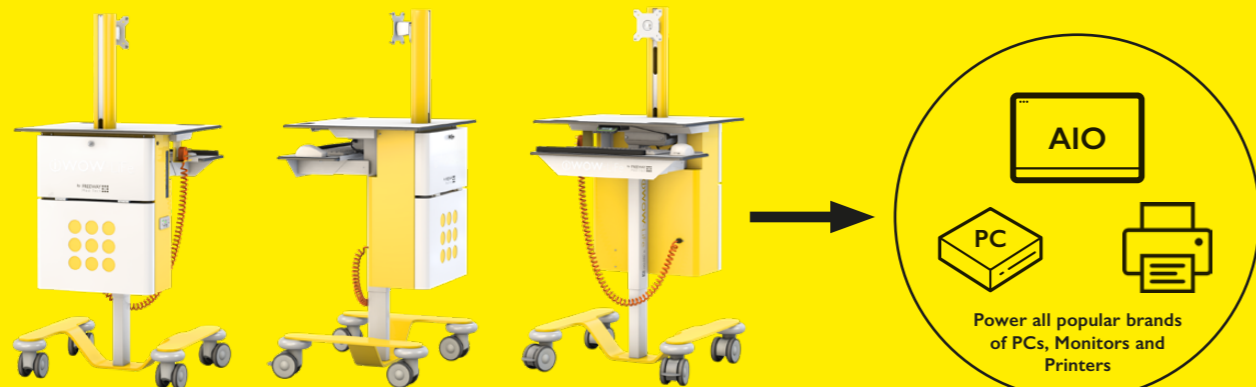

Plug-in
to charge



High capacity
Lithium battery



DC



Intelligent Medical
Power Inverter



AC



Mobile 220V
3-pin outlets x4

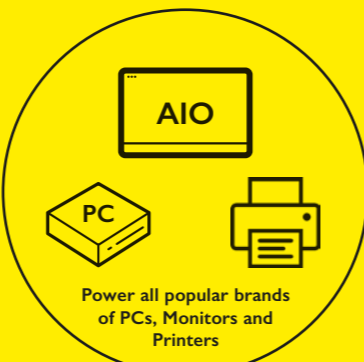

Charge overnight for a full shift* of 'on-the-go' mobile 220V AC power!



iWOW® LiFe - An AC OPTION

If AC power is what you need and it fits with your current IT estate, then iWOW® LiFe is the solution for you!

Available as a bolt-on option for our popular range of iWOW® carts, the iWOW® LiFe offers unrivalled spec in the mobile AC powered carts market.

iWOW-LiFe
A SUPERIOR MOBILE AC POWER OPTION

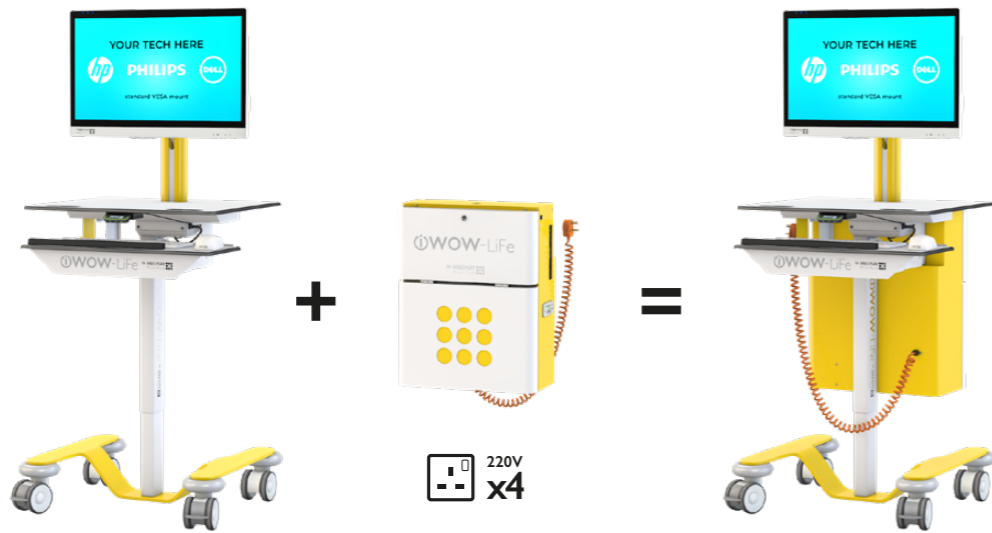

Chosen iWOW model

Choose the iWOW® that suits your purpose as the base to convert to AC power.

Add the AC Pod

A simple bolt-on option transforms the cart's power system providing 220V sockets.

iWOW® LiFe:

An intelligent AC powered workstation on wheels.

Transform an iWOW® - opt for iWOW® LiFe and AC power!

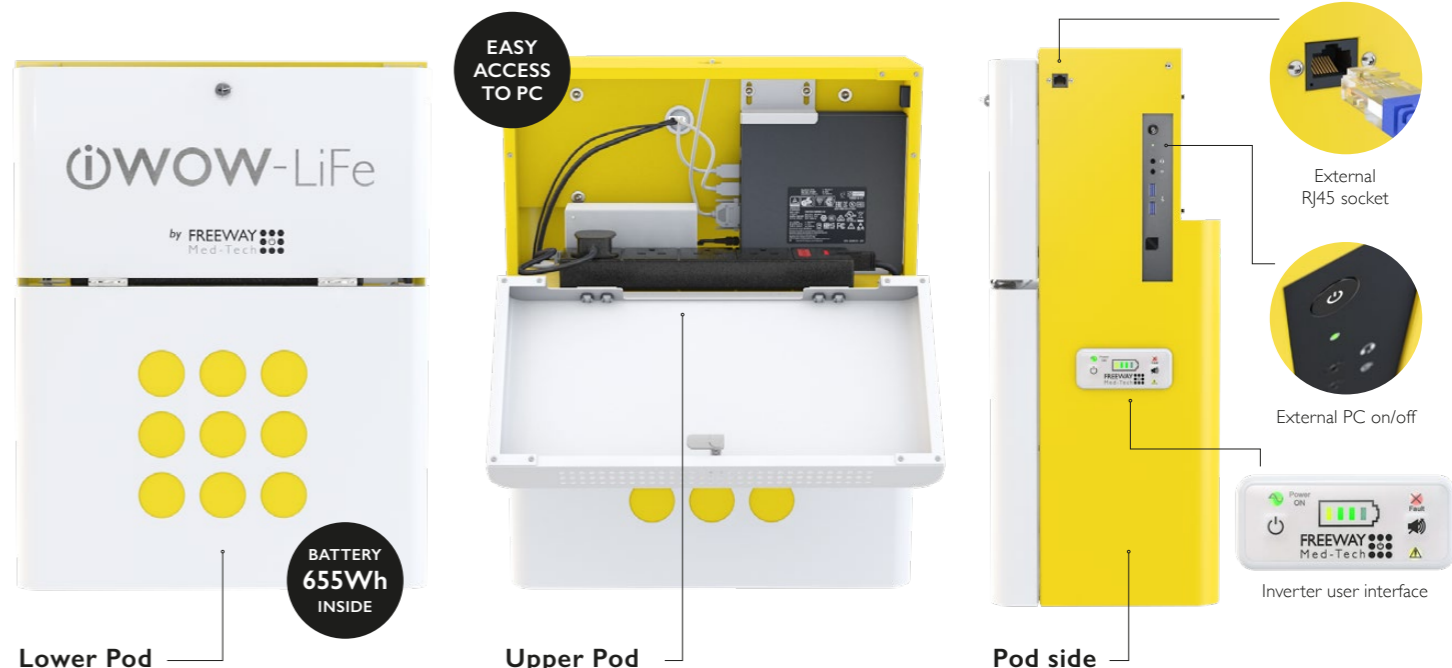

Lower Pod

Houses the clever inverter and lithium battery technology to provide the all-day mobile 220V AC power.

Upper Pod

This is where the MFF PC, transformer, wiring and the 4 x 220V plug sockets are situated. Secured by a key-operated cam lock.

Pod side

Easy access to RJ45 socket, PC on/off switch and other common ports as well as the inverter remote user interface.

iWOW® LiFe - WHY BUY?

Safe in the knowledge...

The inverter we use is rigorously tested and complies with strict regulations known as IEC 60601. The standards are electrical testing regulations that ensure the carts are safe to use in hospital environments, including ITU's and theatres - protecting users and patients from electrical interference.



UL-60601
CERTIFIED



UL-60601 CERTIFIED - Safe for near-patient use and will not interfere with other life critical medical equipment.

iWOW-LiFe
A SUPERIOR MOBILE AC POWER OPTION



Utilise your existing IT estate, no matter what brand it is!

Lower costs...

The iWOW® LiFe powered cart offers an industry-leading 220V AC output so you can operate all your current IT equipment. This reduces the initial startup cost when switching to a Freeway Med-Tech powered cart solution.

PHILIPS



Lenovo



ZEBRA



Monitors & AIOs



Micro PCs



Printers & more

iWOW-LiFe - A SUPERIOR MOBILE AC POWER OPTION



High performance ✓

Our DC-AC inverter is 67% more powerful than the market leader and carries a 5yr warranty!



18+hrs run time ✓

The iWOW® LiFe battery has a whopping 655Whr capacity offering great mobile run-times!



In-house tech ✓

We design and manufacture our intelligent LiFe batteries to match our inverter for better performance and lower costs.



iWOW® LiFe - POWER MANAGEMENT*

Why do we need power management software?

Today's health care providers rely on mobile carts to bring crucial technology directly to the patient's bedside. Capturing data at the point of care is a key component in efforts to improve patient safety and quality of care. Mobile technology needs mobile power. Mobile power needs a tool to manage it.

Freeway Med-Tech's new iWOW® LiFe AC powered carts include MPMview software suite allowing real time information and alerts to keep a fleet of carts on the go. Now, management at any level is easier, from the nurse or clinician using one cart, to the IT manager and service technicians responsible for an entire fleet.

*Available on iWOW® LiFe AC carts only and not the iWOW® range of DC powered carts.

Keep an eye on an entire fleet of iWOW® LiFe carts!

MPM - Clinician's View

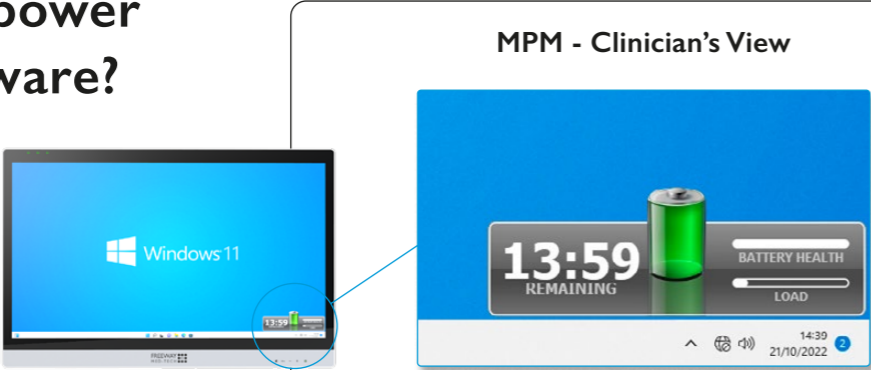

Convenient on screen tool tray icons for easy access status to mobile carts in use on the floor.

- Installs on any mobile medical cart PC
- Reads mobile power status via USB
- Operational with Windows, Linux, or Mac

MPM - Technician's View

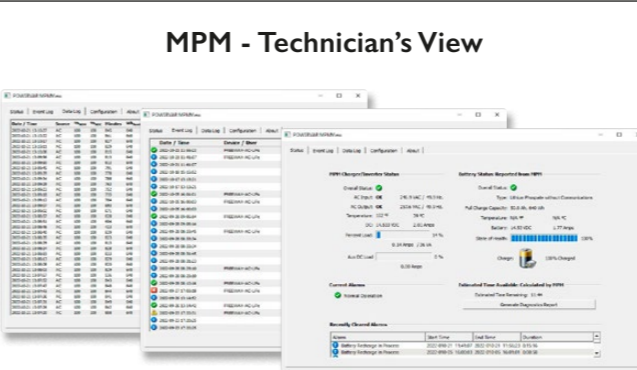

Detailed information for service tech to manage batteries and power supply readiness via LAN or local computer.

- MPM and battery status
- Data Log reports the source of output power and key battery and power measures
- View alarm history by date/time of event to assist in cart usage tracking and service diagnostics.
- Event Log records date and time of all MPM alarms and status indications

MPM - Fleet View

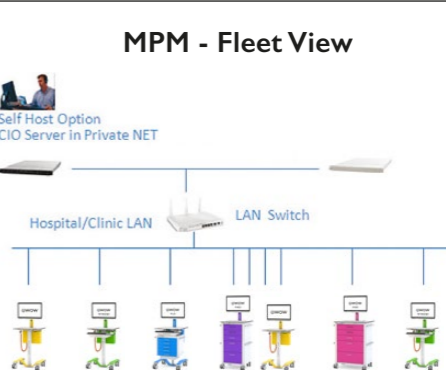

CIO/Fleetview is a simple to use rules-based monitoring and reporting tool to automatically watch over a fleet of carts for battery status and service alarms.

- **Need Service Now Report**
List of devices with active Service alerts – Battery or component faults
- **Need Service Soon Report**
Report of devices that have battery life below some threshold to allow budget planning/service rotation planning for battery replacement

iWOW® LiFe AC - Affordable high performance.



HIGH PERFORMANCE

Our DC-AC inverter is 67% more powerful than the market leader and carries a 5yr warranty!



18+ HRS RUN TIME

The iWOW® LiFe battery has a whopping 655Whr capacity offering great mobile run-times!



IN-HOUSE TECH

We design and manufacture our intelligent LiFe batteries to match our inverter for better performance and lower costs.



I'm IT ready!

Quickly create a feature-packed mobile workstation utilising your existing IT estate, by adding it to our iWOW® LiFe AC. Virtually all MFF PC's and monitors are compatible.

It's literally plug and play!



Use virtually any brand of medical-grade monitor and micro form factor PC.





4 x 240V plug sockets.

That's right, there's four 3-pin UK outlets to power all the popular brands of PCs, Monitors, Printers and peripherals, whilst on the go!

Under the hood, an intelligent medical-grade power inverter's hard at work.

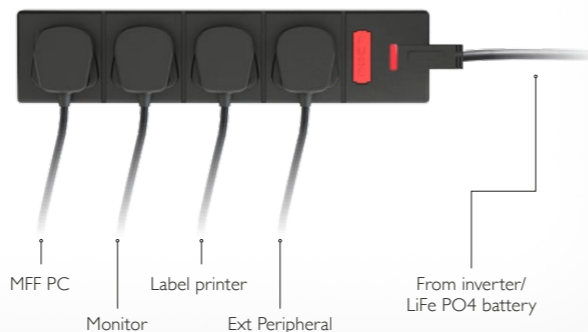

*Actual output voltage is 220V



Charging is simple. Plug it in.

It may be obvious, but just plug the iWOW® LiFe AC into a mains outlet and switch on! Battery status can be viewed on-screen or on the inverter's remote interface.

Supplied with a generous 3.5m of coiled power cord!



The inverter's RUI (remote user interface) is mounted on the side of the rear pod.

Just because we like to market iWOW® LiFe in yellow, it doesn't mean it's not available other colours...

It is - all the colours opposite are available on iWOW® LiFe AC, free of charge!

Yes, that's right. There's no extra charge to have the iWOW® painted in whichever colour opposite, you choose. Whether it's simply to sit better with an existing ward's decor or to denote the cart's use, the choice is yours.

All we ask, is you let us know at point of order.



Digital electric lift with user presets.

iWOW® LiFe AC - electric lift as standard. Featuring 4 user presets that can be stored on the switch to quickly get to a user's height, in an instant.

Let 'it' do all the heavy lifting for you!

When pressed, the digital display shows floor-to-worktop height in centimetres

Not sure if you need storage drawers?

Just add them later....

Yes, simply purchase the required drawer module and fit retrospectively to an iWOW® LiFe AC - Keyboard model.

4 small bolts and it's on!



iWOW® LiFe AC - Keyboard model



Separately purchased iWOW® drawer module (4-drawer model shown here)



The retrospectively purchased drawers are fixed to the pull-out shelf runner brackets



Quickly and painlessly converted into an iWOW® LiFe AC - Plus model

A simple concept that offers the customer flexibility at the initial purchase stage.

What's not to like?



Negative-tilt on a space saving pull-out keyboard & mouse shelf.

The 10° negative-tilt on our keyboard shelves make for a comfortable ergonomic workstation.

Solid Trespa® surfaces ensure durability.



5yr* on-site warranty.

Not only is the iWOW® LiFe's DC-AC medical grade power inverter some 60-70% more powerful than the market leader, it also carries a 5yr on-site warranty to ensure complete piece of mind when running our AC solution.

That's some guarantee!

*Applicable to the power inverter only.



MEDICAL MONITOR

BATTERY POWERED / 24IN



*PC not included

The Freeway Med-Tech battery powered monitor will power a Dell MFF PC and/or peripheral devices!

No need for large expensive 'car battery' style power supplies.

3 x DC outs - 12, 15 & 19V

The 3 different output voltages give flexibility to power up various popular add-on devices.

Example opposite shows use of the 12, 15 & 19V DC outputs.

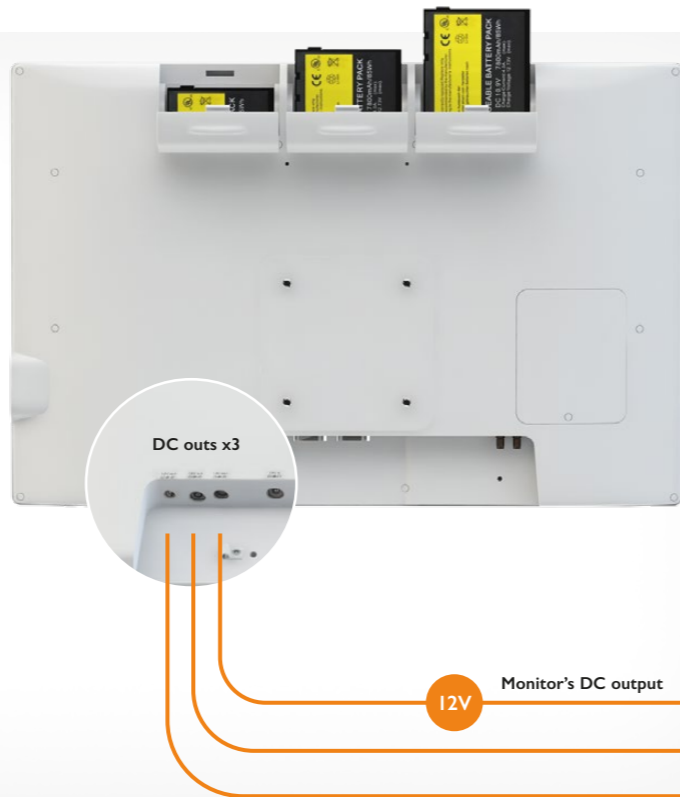

An important peripheral

No need to dock and separately charge this mobile label printer: It is kept topped up all day via the monitor's battery packs.



A full speed workstation

When our MT700 Monitor is used on a mobile workstation, all the power that is required to operate a MFF PC comes direct from the Monitor's DC outs! Popular Dell, HP and Lenovo DC-in voltages supported.



Medical monitors

The 15V output from the MT700-24T can also power important pieces of equipment like these Vital Signs Monitors.



Savings over it's lifetime >

See overleaf why the MT700 Monitor is so economical to own over the long run.

The MT700 Monitor offers low 'cost to entry' for mobile go-anywhere workstations as well as a lower lifecycle cost*.



Already have the PC hardware?

By utilising an existing and suitable Dell MFF PC, the MT700 immediately offers mobile computing together with the benefit of being able to update the PC at a later date relatively inexpensively compared with an AIO system!

*Compared with all-in-one monitor/PCs and/or mobile workstations using large dedicated battery systems.



No dedicated expensive battery packs

Note - All batteries have a performance lifespan

This is why we utilise the highest quality lithium cells from a brand leader and package them up into small individual 90Wh battery packs. The replacement and servicing cost for these smaller units is much lower than older large dedicated battery setups.



Replace inexpensive battery packs



Update separate PC hardware



Continue to operate the MT700 Monitor

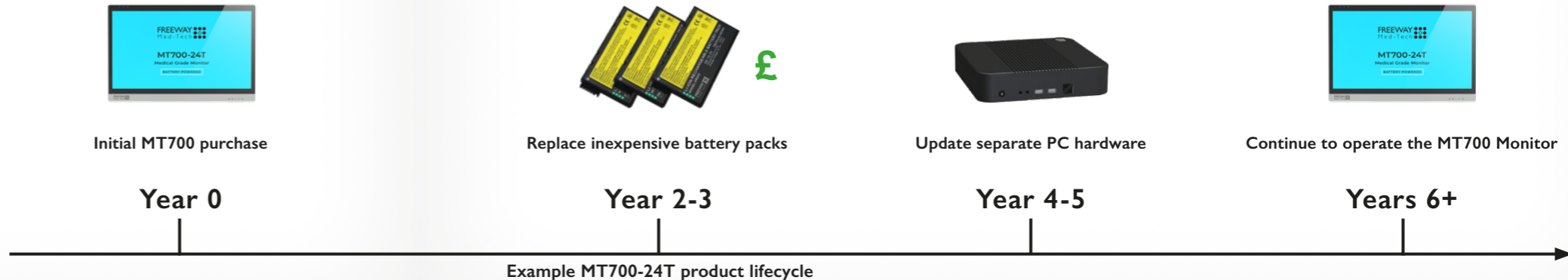

MT700-24T - BATTERY POWERED 24IN MEDICAL MONITOR

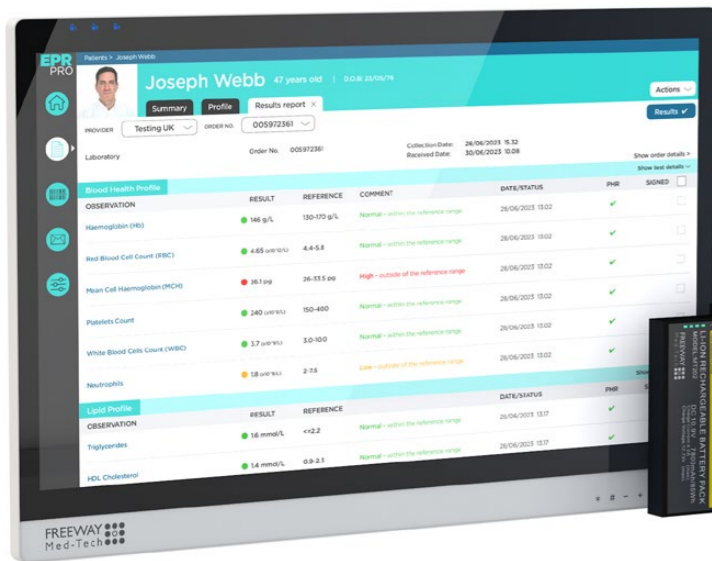

STATE-OF-THE-ART TOUCH SCREEN



10-point multi touch capacitive type screens as standard!

CHARGER DOCK (available separately)



(p. 21/2/3)

Charge up to 6 Li-ion battery packs simultaneously!

PRODUCT CODE

MT700-24T Battery powered 24in touch screen medical grade monitor

The Freeway Med-Tech MT700-24T Battery Powered Monitor offers truly mobile computing for up to an entire shift due to the powerful, hot-swappable rechargeable battery packs. Available with either 1, 2 or 3 Lithium-ion batteries, you choose whether you simply require emergency power back up, or a full shift of wire-free operation. Also features a handy built-in reading light.

DIMENSIONS

Height = 370.9mm Width = 564.4mm Depth = 41.2mm

PRODUCT ELEVATIONS

Front



W

H

Side



D

KEY FEATURES

- Uses up to 3 Lithium-ion batteries for a full shift of mobile operation
- No need to be near mains power
- DC outputs can power a standalone micro form PC and/or computer peripherals
- High contrast 24" capacitive-type touch screen
- Slim fanless design
- UL60601 certified with anti-microbial enclosure
- Withstands common medical environment cleaning chemicals*

MT700-24T - BATTERY POWERED 24IN MEDICAL MONITOR

FRONT



REAR



Uses up to 3 Li-ion batteries

100x100 VESA mounting

COMPREHENSIVE I/O†

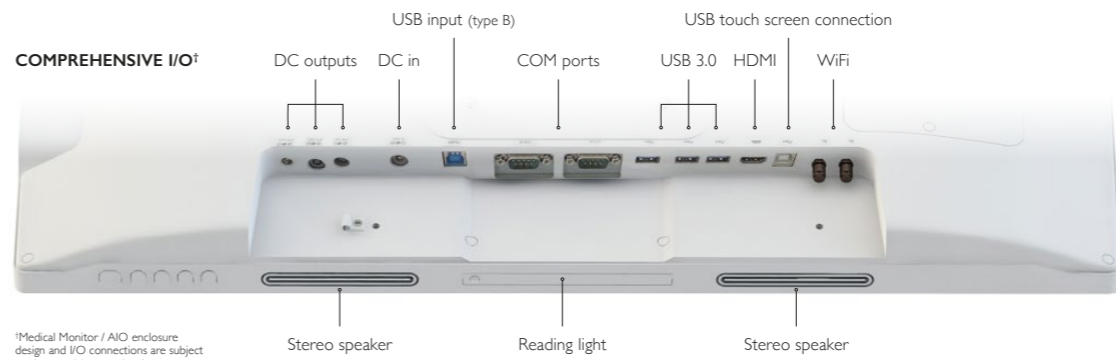

USB input (type B)

USB touch screen connection

DC outputs

DC in

COM ports

USB 3.0

HDMI

WiFi

Stereo speaker

Reading light

Stereo speaker

†Medical Monitor / AIO enclosure design and I/O connections are subject to change without notice. Image may look different to production models.

FREEWAY
Med-Tech



Water resistant enclosures

The screen and rear enclosure are IP rated against dust and moisture ingress, ensuring easy cleaning and disinfection*.

*See pages 228/9 for detailed information on cleaning chemicals and procedures.



Cost effective upgrades

Separate PC allows for easy future IT upgrades.



Battery status made easy

Front facing LED battery indicators offer feedback on the health of each battery.

Clear, front-facing battery status LEDs.

4 stages of charge* on-show at all times. Only a simple glance needed to confirm battery levels.

An important feature, kept simple.

See pages 134-135 for more details.

*Exact percentages can be viewed via the touch onscreen display menu.

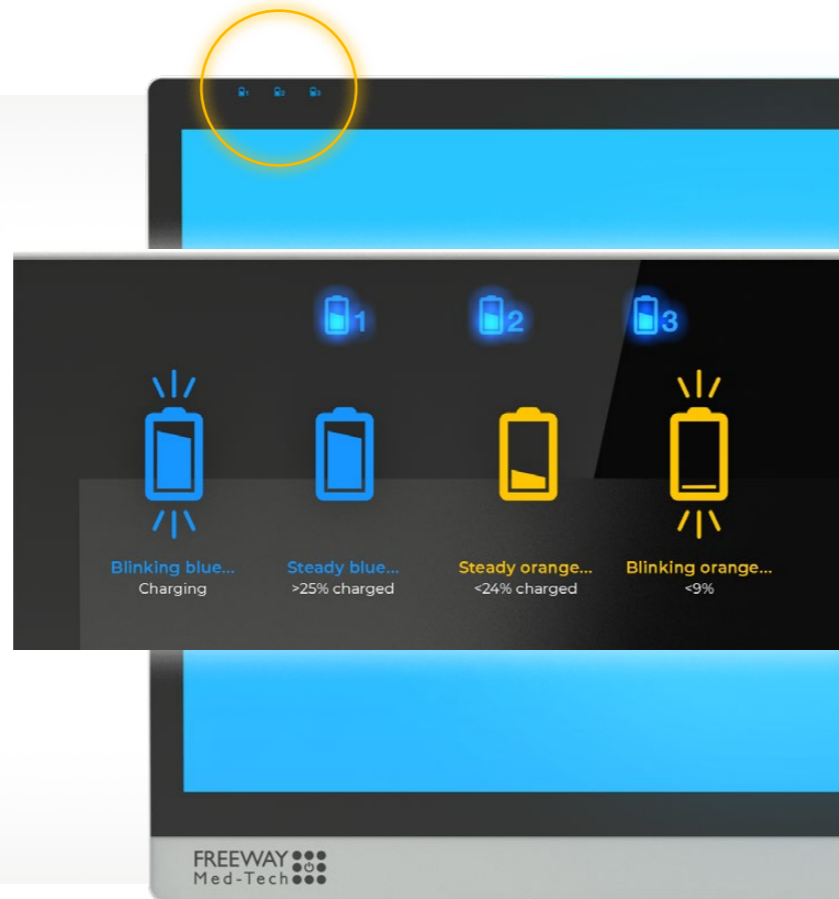

TECHNICAL SPECIFICATIONS

System	
Display	23.8in capacitive touch screen
Display Resolution	1920x1080
Viewing Angle	Horizontal 89°, Vertical 89°
Number of Colours	16.7M
Brightness	250cd/m2
Response Time	16ms
Control Button	1 screen on/off button, 1 menu button, 1 auto/exit button and 2 up/down buttons
Reading Light	LED reading light x 1
Speaker	Built-in speakers
Microphone	Built-in microphones
I/O Ports	
USB Port	USB 3.0 x 6
USB Port for Touch Screen Connection	USB Type-B (2.0) x 1
USB Input Port	USB Type-B (2.0) x 1
HDMI	1
Antenna	Wi-Fi passthrough x 2
DC-in	1
DC-out	12V x 1, 15V x 1, 19V x 1
COM port	2

Mechanical/Environment	
Fan/Fanless	Fanless
AC/DC Adaptor	Input: 100 – 240V AC; Output: 19V DC, 3.78A
Battery Pack	MT202 Li-ion battery; 90Wh, 8250mAh x 3 (optional)
Enclosure	ABS + PC plastics, anti-microbial enclosure
Dimensions (H x W x D)	370.9 x 564.4 x 41.2 mm
Weight	6.5kg (without batteries); 7.8kg (with 3 batteries)
VESA-compliant mounting	100mm x 100mm VESA standard
Regulatory	ANSI/AAMI ES60601-1, IEC60601-1-2, FCC Part 18, FCC Part 15 Class B, IEC 62368-1, RCM, CCC
Temperature	Operation: 0°C – 40°C; Storage: -20°C – 60°C
Humidity	0% – 90% non-condensing
Major options	
Camera	5 megapixel front camera
NFC/RFID reader	Dual frequency, reads both 125KHz and 13.56MHz credentials

MT700-24T ACCESSORIES (available separately)



MT202
Li-ion
battery
pack



MT202
6-gang
battery
charger

An IP65 front bezel. Infection control made easy.

The front of our medical-grade monitors are rated IP65 for dust and moisture ingress. Spray-on cleaners* and anti-bacterial cleaning wipes* can be used without worry of damage.

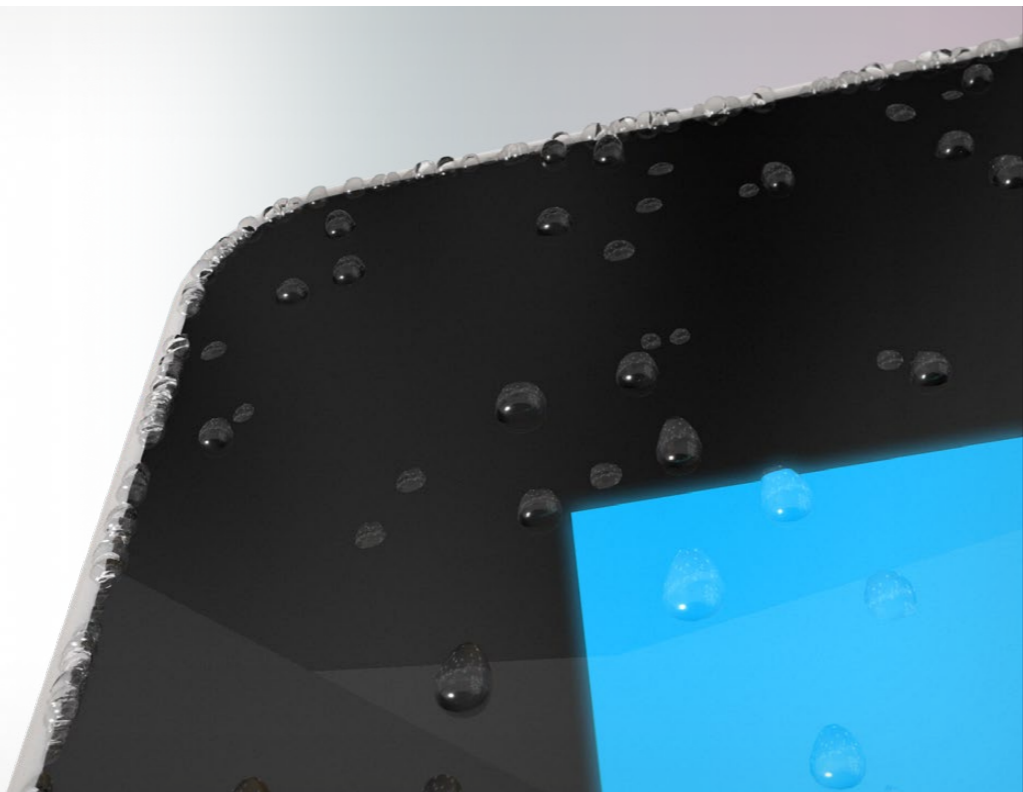

*Suitable cleaning chemicals only. See website for more info.



Night ward rounds made easier with this discreet reading light.

A button operated downward-facing LED light with 4 adjustable brightness settings. Standard equipment on our battery-powered medical monitors and AIO PC's*.

*Available on MT700 and MT500 models

Built-in microphone and speakers.



Yes, we know it's a basic requirement and should be a given on a medical-grade monitor. But believe it or not, some manufacturers do not include them as standard equipment...

There's none of that nonsense here.



Optional built-in* RFID card reader.

All our Monitors, AIO PC's and tablets offer Imprivata® RFID card readers as factory-fitted optional equipment.

Log-in as quick as paying for your morning coffee!



*Must be specified at time of order.

Battery status. Constantly visible.

The Freeway Med-Tech MT500-24T (AIO) and the MT700-24T (Monitor) products feature an intuitive LED battery health indicator system that is always visible at the top of the panel.

Simply by glancing at the top left of the screen, the user can quickly see if the batteries are; fully charged, partly charged or are in need of immediate charging. The same indicators will also tell the user when the unit is plugged in and charging.

See the images opposite for the indication of each stage.

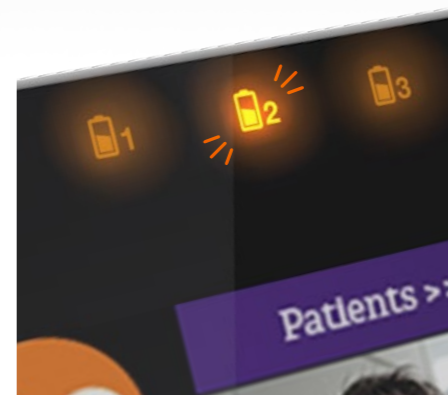
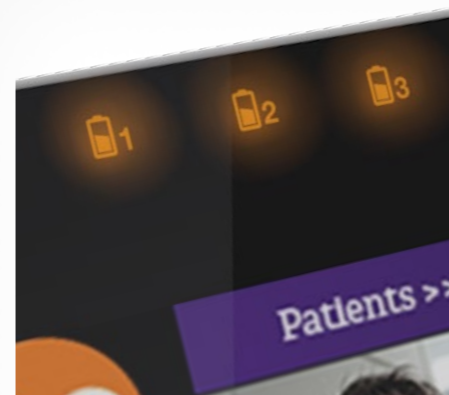
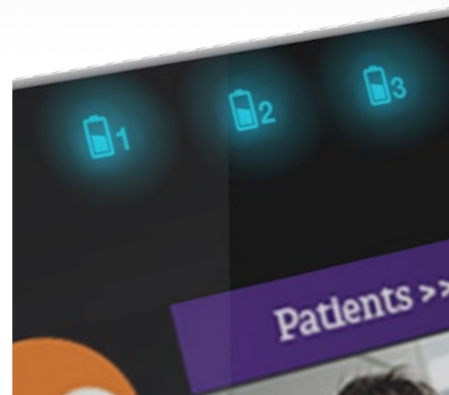
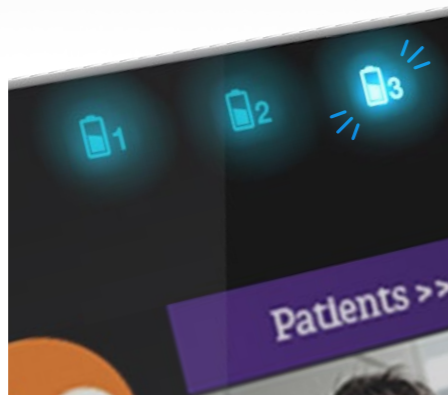

So, what do the battery status LEDs mean?



A blinking blue indicator...

This means the corresponding battery is charging.



A solid blue indicator...

This means the corresponding battery is charged 25% and above. No need to worry about charging in the near term.



A solid orange indicator...

This means the corresponding battery is charged between 24-10%. The user should be aware that the pack will need charging soon.



A blinking orange indicator...

This means the corresponding battery is charged 9% or less. The user should swap out the battery or plug the iVOW into a mains socket (if applicable).

The on-screen menu

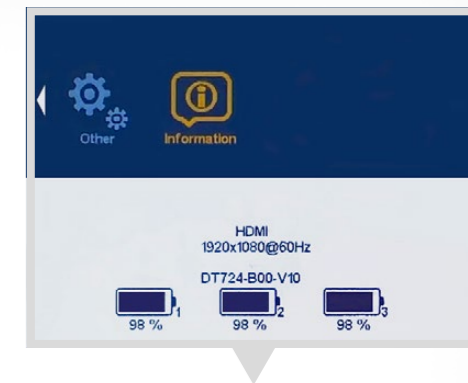

Exact percentages
can be seen by entering the menu using the monitor's function buttons.

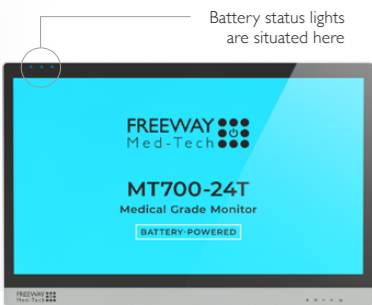



MEDICAL MONITOR

MAINS POWERED / 24IN

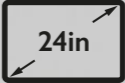

*PC not included

MT600-24T - MAINS POWERED 24IN MEDICAL MONITOR

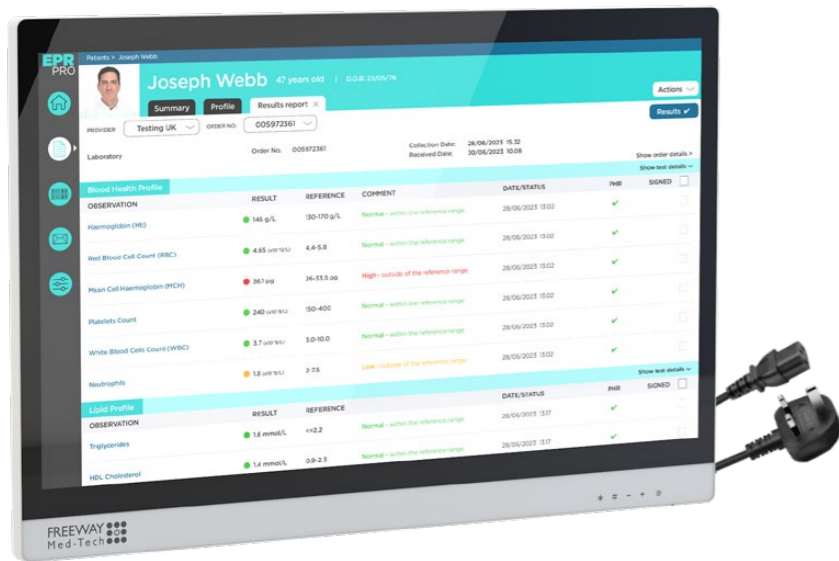

STATE-OF-THE-ART TOUCH SCREEN



10-point multi touch capacitive type screens as standard!

MAINS POWERED (iWOW required to be plugged-in)



PRODUCT CODE

MT600-24T Mains powered 24in touch screen medical grade monitor

The Freeway Med-Tech MT600-24T Mains Powered Monitor offers the same technical specification and features as our battery powered model, just with the need for a permanent 240V mains supply. For use where an iWOW will be predominately used in a fixed location.

DIMENSIONS

Height = 370.9mm Width = 564.4mm Depth = 41.2mm

PRODUCT ELEVATIONS

Front

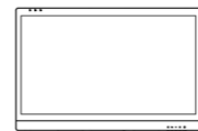

W

H

Side



D

KEY FEATURES

- 240V mains operated
- High contrast 24" capacitive-type touch screen
- Fanless design
- Full-HD (1920x1080) resolution
- UL60601 certified with anti-microbial enclosure
- Withstands common medical environment cleaning chemicals*
- OPTIONAL front camera and RFID reader available

MT600-24T - MAINS POWERED 24IN MEDICAL MONITOR

FRONT



REAR



100x100 VESA mounting

COMPREHENSIVE I/O†

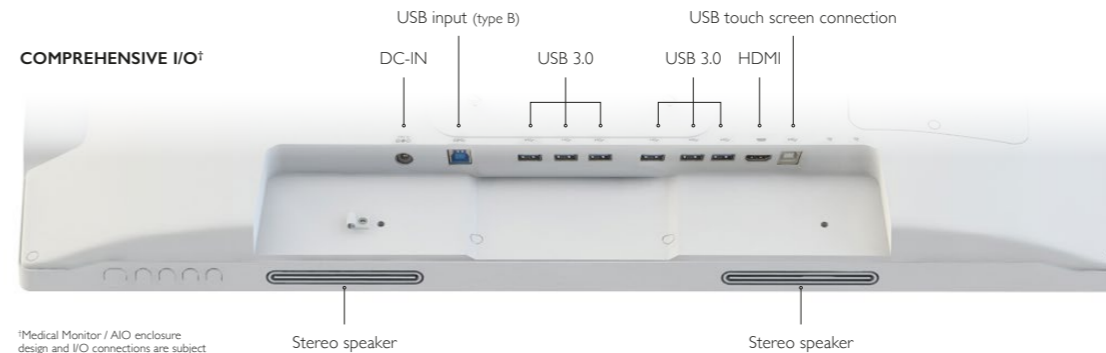

†Medical Monitor / AIO enclosure design and I/O connections are subject to change without notice. Image may look different to production models.



Water resistant enclosures

The screen and rear enclosure are IP rated against dust and moisture ingress, ensuring easy cleaning and disinfection*.

*See pages 228/9 for detailed information on cleaning chemicals and procedures.



Cost effective upgrades

Separate PC allows for easy future IT upgrades.



Mains powered

Requires a permanent 240V mains outlet for use.



Touch screen input

All monitors and AIO's feature state of the art 10-point multi-touch capacitive type touch screens.

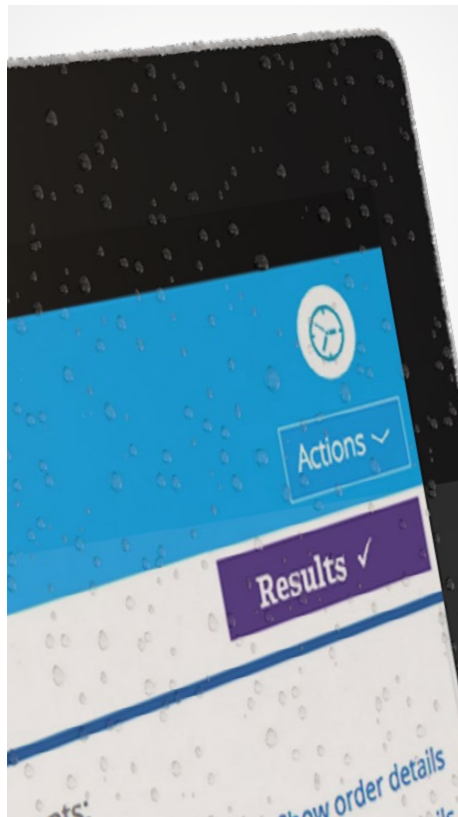

Moisture resistant medical-grade front panel

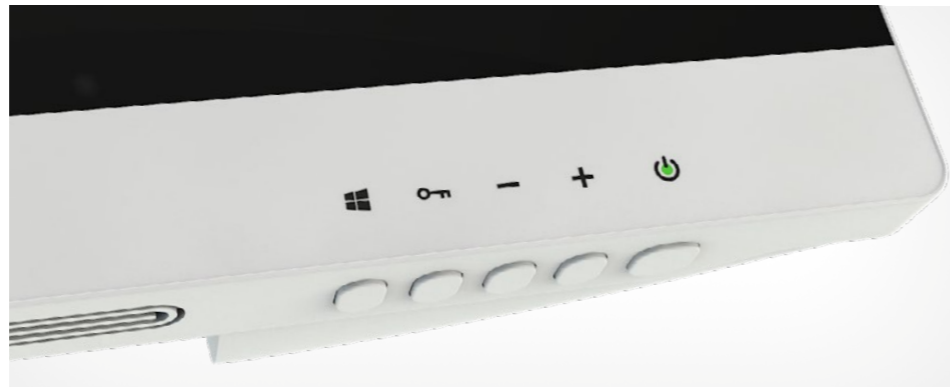

Built-in speakers and clear easy-to-use function buttons located on the underside of the monitor

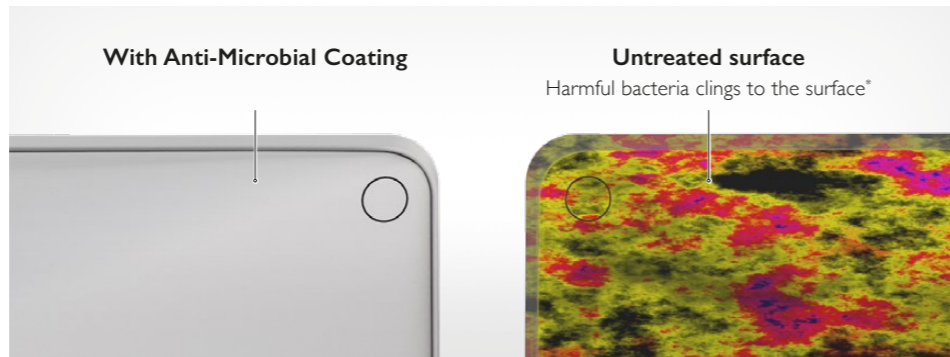

Anti-microbial enclosure resists bacteria transmission

TECHNICAL SPECIFICATIONS

System	
Display	23.8in capacitive touch screen
Display Resolution	1920x1080
Viewing Angle	Horizontal 89°, Vertical 89°
Number of Colours	16.7M
Brightness	250cd/m2
Response Time	16ms
Control Button	1 screen on/off button, 1 menu button, 1 auto/exit button and 2 up/down buttons
Speaker	Built-in speakers
Microphone	Built-in microphones
I/O Ports	
USB Port	USB 3.0 x 6
USB Port for Touch Screen Connection	USB Type-B (2.0) x 1
USB Input Port	USB Type-B (3.0) x 1
HDMI	1
Antenna	Wi-Fi passthrough x 2
DC-in	1

Mechanical/Environment	
Fan/Fanless	Fanless
AC/DC Adaptor	Input: 100 – 240V AC; Output: 19V DC, 3.78A
Enclosure	ABS + PC plastics, anti-microbial enclosure
Dimensions (H x W x D)	370.5 x 567 x 45.2mm
Weight	6.4kg
VESA-compliant mounting	100mm x 100mm VESA standard
Regulatory	ANSI/AAMI ES60601-1, IEC60601-1-2, FCC Part 18, FCC Part 15 Class B, IEC 62368-1, RCM, CCC
Temperature	Operation: 0°C to 40°C; Storage: -10°C to 50°C
Humidity	0% – 90% non-condensing
Major options	
Camera	5 megapixel front camera
NFC/RFID reader	Dual frequency, reads both 125KHz and 13.56MHz credentials

*For illustrative purposes only. Bacteria cannot be seen with the naked eye.



MEDICAL AIO

BATTERY POWERED / 24IN



Freeway Med-Tech's battery powered AIOs use desktop-class processors.

Not all i5 CPUs are equal!

Check out the comparisons opposite...

Graph Performance Key >

Taller bars and higher numbers in the graphs indicate better performance. For example, a score of 10000 shows a CPU is twice as powerful as one rated at 5000.

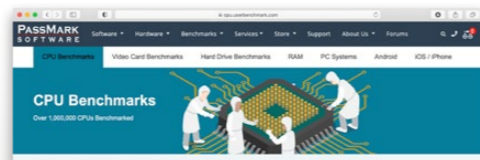
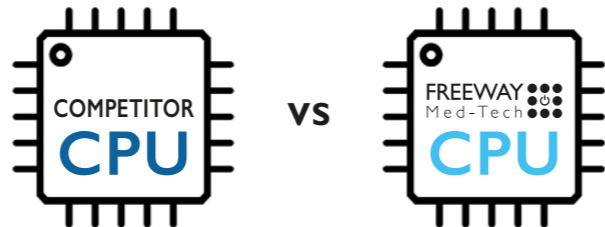

Comparisons shown opposite, use the popular **Passmark Rating** generated via the website www.cpubenchmark.net

Our competitors' CPU Passmark Rating* VS the Freeway Med-Tech AIO processor family

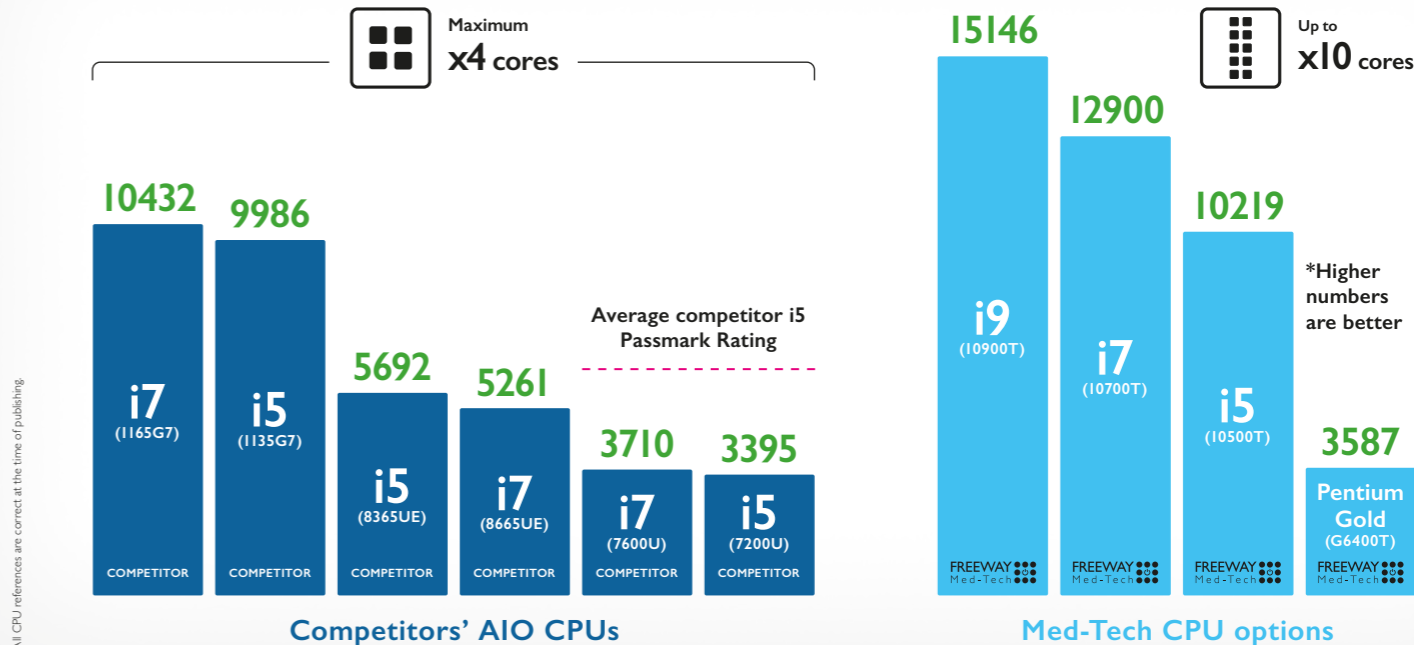



Put simply, we knock the socks off our rivals' AIO processors!

NHS Trust's save £1000's by purchasing our i5 AIO for an entire fleet of workstations, when compared with purchasing a competitors' i7 model. **AND, not only is there a huge cost saving, the performance would be better too! What's not to like?**

See yet more performance comparisons opposite...

Comparisons shown, use the popular **User Benchmark** scores generated via the website cpu.userbenchmark.com

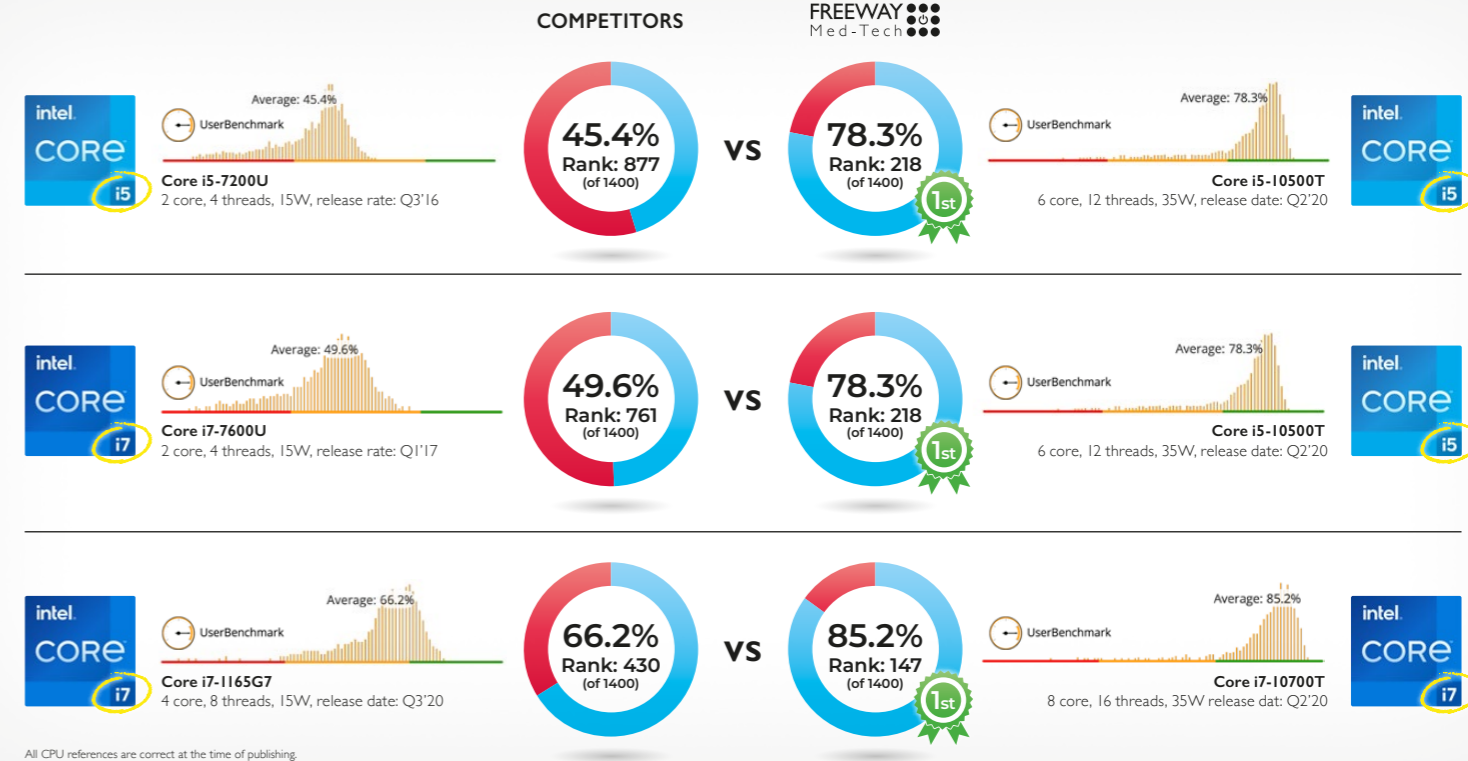
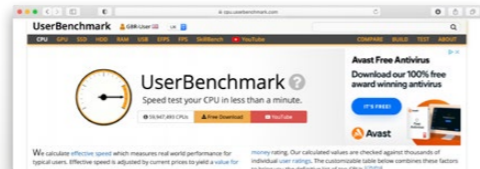

MT500-24T - AIO BATTERY POWERED 24IN MEDICAL PC

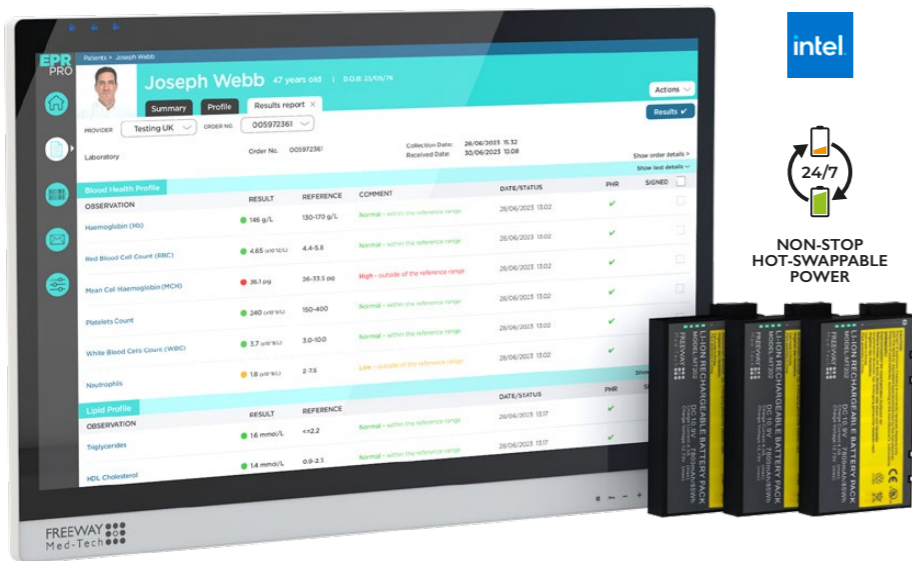

STATE-OF-THE-ART TOUCH SCREEN



10-point multi touch capacitive type screens as standard!

CHARGER DOCK (available separately)



(p. 21/2/3)

Charge up to 6 Li-ion battery packs simultaneously!

PRODUCT CODE

MT500-24T Battery powered 24in AIO touch screen medical grade monitor/PC

The Freeway Med-Tech MT500-24T Battery Powered All-In-One Monitor/PC offers fully mobile computing with its powerful, hot-swappable rechargeable battery packs. Options for 1, 2 or 3 Lithium-ion batteries allow for either an emergency power back up, or totally wire-free operation. Also features a handy built-in reading light.

DIMENSIONS

Height = **370.9mm** Width = **564.4mm** Depth = **41.2mm**

PRODUCT ELEVATIONS

Front



W

H

Side



D

KEY FEATURES

- Uses up to 3 Lithium-ion batteries for a full shift of mobile operation
- No need to be near mains power
- Intel Core-i5/7/9 processors
- Runs Microsoft® Windows® / Linux / Igel
- DC outputs can power PC peripherals and other medical equipment
- High contrast 24" capacitive-type touch screen
- Slim fanless design
- UL60601 certified with anti-microbial enclosure
- Withstands common medical environment cleaning chemicals*

MT500-24T - AIO BATTERY POWERED 24IN MEDICAL PC

FRONT



REAR



Uses up to 3 Li-ion batteries

100x100 VESA mounting

COMPREHENSIVE I/O†

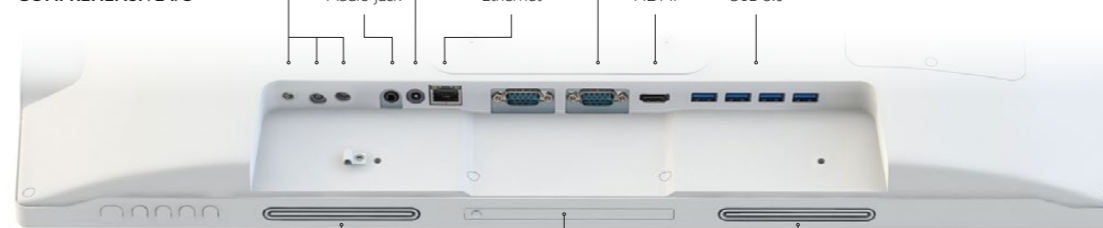

Stereo speaker

Reading light

Stereo speaker

†Medical Monitor / AIO enclosure design and I/O connections are subject to change without notice. Image may look different to production models.

FREWAY
Med-Tech



Water resistant enclosures

The screen and rear enclosure are IP rated against dust and moisture ingress, ensuring easy cleaning and disinfection*.

*See pages 228/9 for detailed information on cleaning chemicals and procedures.



Choice of processor

Modern Intel® Core-i5/7/9 range of processors to choose from.



Optional DC-out

Can power PC peripherals and other medical equipment.



Battery status made easy

Front facing LED battery indicators offer feedback on the health of each battery.



Easily hot-swap battery packs in a matter of seconds



Clear battery status LEDs



Moisture resistant medical-grade front panel

Choice of processors from the 10th generation Intel Core i range!



A choice of 6 to 10 cores of Intel processing power:



The OPTIONAL DC-out can power PC peripherals!



Windows OS
IoT Enterprise version available for pre-install with or without license.

Linux/Igel operating systems can also be installed.

Industry standard OS for medical software and systems.

TECHNICAL SPECIFICATIONS

System	
CPU	Intel® Core™ i5-10500T, 2.3 GHz (up to 3.8GHz) - 6 core Intel® Core™ i7-10700T, 2.0 GHz (up to 4.5GHz) - 8 core Intel® Core™ i9-10900T, 1.9 GHz (up to 4.6GHz) - 10 core
RAM	8GB to 64GB
Storage	256Gb to 4TB Flash (mPCIe NVMe type SSD)
Operating System	Microsoft® Windows®/Linux/Igel - specify pre-install if required
Display	23.8in capacitive touch screen
Display resolution	1920x1080
Trusted platform module	TPM 2.0
Reading light	LED reading light x 1
Microphone and speaker	Built-in microphones and speaker
Network Interface	
WLAN	Ethernet 10/100/1000 MB Base-T LAN; Wi-Fi 802.11ax, 2.4GHz/5GHz dual band
Bluetooth	Bluetooth 5.1
I/O Ports	
USB Ports	USB 2.0 x 2 and USB 3.0 x 4
COM Port	2
HDMI-out (1.4a)	1
Audio Jack	1
Ethernet	RJ45 connector for ethernet x 1
DC-in	1
DC-out (optional)	12V x 1, 15V x 1, 19V x 1

Faster processors than our competitors!

Our Intel® Core i5 CPU is effectively 30% faster in real-world benchmark tests.

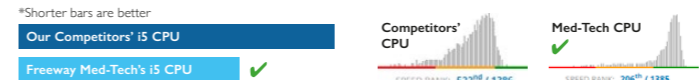

Mechanical/Environmental	
Fan/Fanless	Fanless
AC/DC Adaptor	Input: 100 – 240V AC; Output: 19V DC, 6.31A
Battery Pack	MT202 Li-ion battery, 85Wh, 7800mAh x 3 (optional)
Enclosure	ABS + PC plastics, anti-microbial enclosure
Dimensions (H x W x D)	370.9 x 564.4 x 41.2mm
Weight	7.4kg (without battery) - 8.8kg (with 3 batteries)
VESA-compliant mounting	100mm x 100mm VESA standard
Water Resistance	Front panel: IP65; Enclosure: IPX2
Regulatory	ANSI/AAMI ES60601-1, IEC60601-1, FCC Part 18, FCC Part 15 Class B, GB 17625.1, GB 4943.1, GB/T 9254, CE-EMC, CE-RED, RCM, CCC
Major options	
Camera	Full-HD front camera
NFC/RFID reader	Dual frequency, reads both 125KHz and 13.56MHz credentials
Smart Card/CAC Reader	Full-slot, reads ISO 7816 T=0, T=1; 1.8/3/5V smart card



MT500-24T ACCESSORIES (available separately)



MT500-24T - PENTIUM™ PROCESSOR - STORAGE AND MEMORY CHOICE

Choose your performance spec based around the Intel® Pentium™ central processing unit.

Delivered ready to switch on, each Freeway Med-Tech AIO monitor/PC is pre-installed with an OS ready to enter your license details.

A standard warranty of 12 months from date of purchase covers any faulty components or workmanship with the option to extend this by an extra 48 months to 5 years in total from date of purchase.



Please quote the correct part number opposite when ordering as all units are custom built.

MT500-24T with Intel® Pentium™ CPU

23.6in Medical Cart Computer with capacitive touch LCD, Intel® 10th Gen Pentium™ processor, medical grade AC/DC adapter.



Part Number	Operating System	Storage	RAM	Standard Warranty	Extended Warranty*
MT500-24T-584TP0-X-495	Specify when ordering	256GB	8GB	12 months	60 months
MT500-24T-584TP0-X-595	Specify when ordering	256GB	16GB	12 months	60 months
MT500-24T-584TP0-X-5A5	Specify when ordering	512GB	16GB	12 months	60 months

*Extended Warranty available as a cost option, please enquire for prices at time of order. Extended Warranty must be ordered at time of purchase. Extended Warranty is a 48 month extension on top of the standard 12 months offered, to provide 60 months from date of first purchase.

MT500-24T - i5 PROCESSOR - STORAGE AND MEMORY CHOICE

Choose your performance spec based around the powerful Intel® i5 Core™ central processing unit.

Delivered ready to switch on, each Freeway Med-Tech AIO monitor/PC is pre-installed with an OS ready to enter your license details.

A standard warranty of 12 months from date of purchase covers any faulty components or workmanship with the option to extend this by an extra 48 months to 5 years in total from date of purchase.



Please quote the correct part number opposite when ordering as all units are custom built.

MT500-24T with Intel® i5 Core™ CPU

23.6in Medical Cart Computer with capacitive touch LCD, Intel® 10th Gen i5 Core™ processor, medical grade AC/DC adapter.



Part Number	Operating System	Storage	RAM	Standard Warranty	Extended Warranty*
MT500-24T-584T50-X-495	Specify when ordering	256GB	8GB	12 months	60 months
MT500-24T-584T50-X-595	Specify when ordering	256GB	16GB	12 months	60 months
MT500-24T-584T50-X-5A5	Specify when ordering	512GB	16GB	12 months	60 months

*Extended Warranty available as a cost option, please enquire for prices at time of order. Extended Warranty must be ordered at time of purchase. Extended Warranty is a 48 month extension on top of the standard 12 months offered, to provide 60 months from date of first purchase.

MT500-24T - i7 PROCESSOR - STORAGE AND MEMORY CHOICE

Choose your performance spec based around the powerful Intel® i7 Core™ central processing unit.

Delivered ready to switch on, each Freeway Med-Tech AIO monitor/PC is pre-installed with an OS ready to enter your license details.

A standard warranty of 12 months from date of purchase covers any faulty components or workmanship with the option to extend this by an extra 48 months to 5 years in total from date of purchase.



! Please quote the correct part number opposite when ordering as all units are custom built.

MT500-24T with Intel® i7 Core™ CPU

23.6in Medical Cart Computer with capacitive touch LCD, Intel® 10th Gen i7 Core™ processor, medical grade AC/DC adapter. Supplied with 3 x MT202 Batteries.



Part Number	Operating System	Storage	RAM	Standard Warranty	Extended Warranty*
MT500-24T-584T70-X-495	Specify when ordering	256GB	8GB	12 months	60 months
MT500-24T-584T70-X-595	Specify when ordering	256GB	16GB	12 months	60 months
MT500-24T-584T70-X-5A5	Specify when ordering	512GB	16GB	12 months	60 months

*Extended Warranty available as a cost option, please enquire for prices at time of order. Extended Warranty must be ordered at time of purchase. Extended Warranty is a 48 month extension on top of the standard 12 months offered, to provide 60 months from date of first purchase.

MT500-24T - i9 PROCESSOR - STORAGE AND MEMORY CHOICE

Choose your performance spec based around the powerful Intel® i9 Core™ central processing unit.

Delivered ready to switch on, each Freeway Med-Tech AIO monitor/PC is pre-installed with an OS ready to enter your license details.

A standard warranty of 12 months from date of purchase covers any faulty components or workmanship with the option to extend this by an extra 48 months to 5 years in total from date of purchase.



! Please quote the correct part number opposite when ordering as all units are custom built.

MT500-24T with Intel® i9 Core™ CPU

23.6in Medical Cart Computer with capacitive touch LCD, Intel® 10th Gen i9 Core™ processor, medical grade AC/DC adapter. Supplied with 3 x MT202 Batteries.



Part Number	Operating System	Storage	RAM	Standard Warranty	Extended Warranty*
MT500-24T-584T90-X-495	Specify when ordering	256GB	8GB	12 months	60 months
MT500-24T-584T90-X-595	Specify when ordering	256GB	16GB	12 months	60 months
MT500-24T-584T90-X-5A5	Specify when ordering	512GB	16GB	12 months	60 months

*Extended Warranty available as a cost option, please enquire for prices at time of order. Extended Warranty must be ordered at time of purchase. Extended Warranty is a 48 month extension on top of the standard 12 months offered, to provide 60 months from date of first purchase.



MEDICAL AIO

BATTERY POWERED / 22IN



MT500-22T - AIO BATTERY POWERED 22IN MEDICAL PC

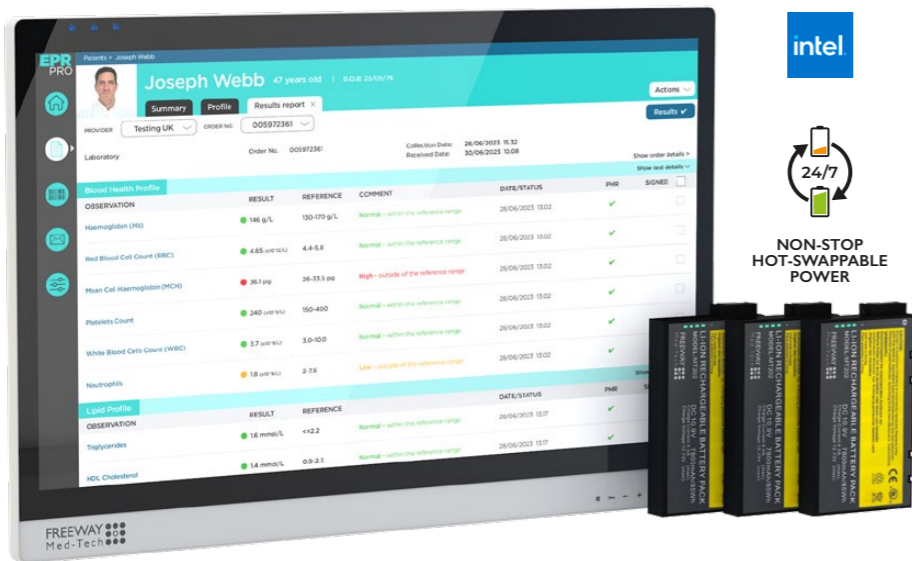

STATE-OF-THE-ART TOUCH SCREEN



10-point multi touch capacitive type screens as standard!

CHARGER DOCK (available separately)



(p. 212/3)

Charge up to 6 Li-ion battery packs simultaneously!

PRODUCT CODE

MT500-22T Battery powered 22in AIO touch screen medical grade monitor/PC

The Freeway Med-Tech MT500-22T Battery Powered All-In-One Monitor/PC offers fully mobile computing with its powerful, hot-swappable rechargeable battery packs. Options for 1, 2 or 3 Lithium-ion batteries allow for either an emergency power back up, or totally wire-free operation. Also features a handy built-in reading light.

DIMENSIONS

Height = **345.9mm** Width = **516.9mm** Depth = **40.4mm**

PRODUCT ELEVATIONS

Front

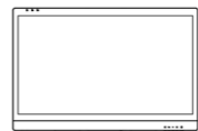

W

H

Side



D

KEY FEATURES

- Uses up to 3 Lithium-ion batteries for a full shift of mobile operation
- No need to be near mains power
- Intel Core-i5/7/9 processors
- Runs Microsoft® Windows® / Linux / Igel
- DC outputs can power PC peripherals and other medical equipment
- High contrast 22" capacitive-type touch screen
- Slim fanless design
- UL6061 certified with anti-microbial enclosure
- Withstands common medical environment cleaning chemicals*

MT500-22T - AIO BATTERY POWERED 22IN MEDICAL PC

FRONT



REAR



COMPREHENSIVE I/O†

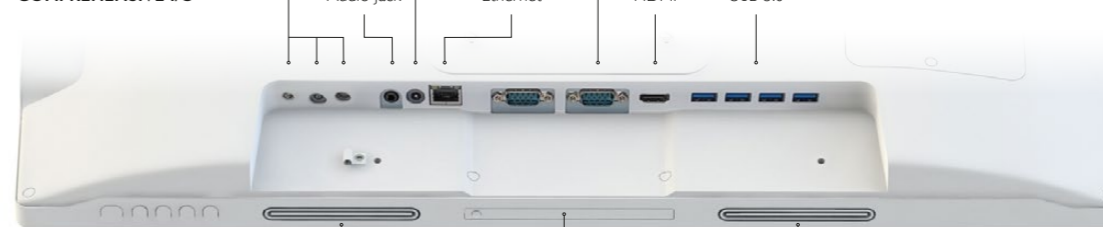

Stereo speaker

Reading light

Stereo speaker

†Medical Monitor / AIO enclosure design and I/O connections are subject to change without notice. Image may look different to production models.

FREWAY
Med-Tech



Water resistant enclosures

The screen and rear enclosure are IP rated against dust and moisture ingress, ensuring easy cleaning and disinfection*.

*See pages 228/9 for detailed information on cleaning chemicals and procedures.



Choice of processor

Modern Intel® Core-i7/9 range of processors to choose from.



Optional DC-out

Can power PC peripherals and other medical equipment.



Battery status made easy

Front facing LED battery indicators offer feedback on the health of each battery.



Easily hot-swap battery packs in a matter of seconds



Clear battery status LEDs



The **OPTIONAL** DC-out can power PC peripherals!



Moisture resistant medical-grade front panel

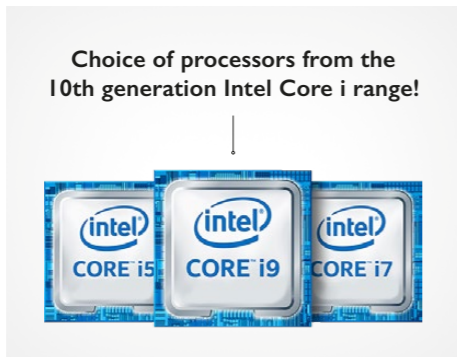

Choice of processors from the 10th generation Intel Core i range!

A choice of 6 to 10 cores of Intel processing power:



Windows OS
IoT Enterprise version available for pre-install with or without license.

Linux/Igel operating systems can also be installed.

Industry standard OS for medical software and systems.

TECHNICAL SPECIFICATIONS

System	
CPU	Intel® Core™ i5-10500T, 2.3 GHz (up to 3.8GHz) - 6 core Intel® Core™ i7-10700T, 2.0 GHz (up to 4.5GHz) - 8 core Intel® Core™ i9-10900T, 1.9 GHz (up to 4.6GHz) - 10 core
RAM	8GB to 64GB
Storage	256Gb to 4TB Flash (mPCIe NVMe type SSD)
Operating System	Microsoft® Windows®/Linux/Igel - specify pre-install if required
Display	21.5in capacitive touch screen
Display resolution	1920x1080
Trusted platform module	TPM 2.0
Reading light	LED reading light x 1
Microphone and speaker	Built-in microphones and speaker
Network Interface	
WLAN	Ethernet 100/1000 MB Base-T LAN; Wi-Fi 802.11ax, 2.4GHz/5GHz dual band
Bluetooth	Bluetooth 5.1
I/O Ports	
USB Ports	USB 2.0 x 2 and USB 3.0 x 4
COM Port	2
HDMI-out (1.4a)	1
Audio Jack	1
Ethernet	RJ45 connector for ethernet x 1
DC-in	1
DC-out (optional)	12V x 1, 15V x 1, 19V x 1

Mechanical/Environmental	
Fan/Fanless	Fanless
AC/DC Adaptor	Input: 100 – 240V AC; Output: 19V DC, 6.31A
Battery Pack	MT202 Li-ion battery, 85Wh, 7800mAh x 3 (optional)
Enclosure	ABS + PC plastics, anti-microbial enclosure
Dimensions (H x W x D)	345.9 x 516.9 x 40.4mm
Weight	7.3kg (without battery) - 8.7kg (with 3 batteries)
VESA-compliant mounting	100mm x 100mm VESA standard
Water Resistance	Front panel: IP65; Enclosure: IPX2
Regulatory	ANSI/AAMI ES60601-1, IEC60601-1, FCC Part 18, FCC Part 15 Class B, GB 17625.1, GB 4943.1, GB/T 9254, CE-EMC, CE-RED, RCM, CCC
Major options	
Camera	Full-HD front camera
NFC/RFID reader	Dual frequency, reads both 125KHz and 13.56MHz credentials
Smart Card/CAC Reader	Full-slot, reads ISO 7816 T=0, T=1; 1.8/3/5V smart card

Intel® WiFi Series 6 Module as standard ✓

Optional Privata-compatible RFID reader module ✓

Optional HID® Smart Card Reader ✓

Faster processors than our competitors!

Our Intel® Core i5 CPU is effectively 30% faster in real-world benchmark tests.

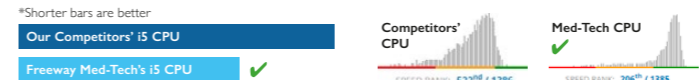

MT500-22T ACCESSORIES (available separately)



MT500-22T - PENTIUM™ PROCESSOR - STORAGE AND MEMORY CHOICE

Choose your performance spec based around the Intel® Pentium™ central processing unit.

Delivered ready to switch on, each Freeway Med-Tech AIO monitor/PC is pre-installed with an OS ready to enter your license details.

A standard warranty of 12 months from date of purchase covers any faulty components or workmanship with the option to extend this by an extra 48 months to 5 years in total from date of purchase.



! Please quote the correct part number opposite when ordering as all units are custom built.

MT500-22T with Intel® Pentium™ CPU

21.5in Medical Cart Computer with capacitive touch LCD, Intel® 10th Gen Pentium™ processor, medical grade AC/DC adapter.



Part Number	Operating System	Storage	RAM	Standard Warranty	Extended Warranty*
MT500-22T-582TP0-X-495	Specify when ordering	256GB	8GB	12 months	60 months
MT500-22T-582TP0-X-595	Specify when ordering	256GB	16GB	12 months	60 months
MT500-22T-582TP0-X-5A5	Specify when ordering	512GB	16GB	12 months	60 months

*Extended Warranty available as a cost option, please enquire for prices at time of order. Extended Warranty must be ordered at time of purchase. Extended Warranty is a 48 month extension on top of the standard 12 months offered, to provide 60 months from date of first purchase.

MT500-22T - i5 PROCESSOR - STORAGE AND MEMORY CHOICE



Choose your performance spec based around the powerful Intel® i5 Core™ central processing unit.

Delivered ready to switch on, each Freeway Med-Tech AIO monitor/PC is pre-installed with an OS ready to enter your license details.

A standard warranty of 12 months from date of purchase covers any faulty components or workmanship with the option to extend this by an extra 48 months to 5 years in total from date of purchase.



! Please quote the correct part number opposite when ordering as all units are custom built.

MT500-22T with Intel® i5 Core™ CPU

21.5in Medical Cart Computer with capacitive touch LCD, Intel® 10th Gen i5 Core™ processor, medical grade AC/DC adapter.



Part Number	Operating System	Storage	RAM	Standard Warranty	Extended Warranty*
MT500-22T-582T50-X-495	Specify when ordering	256GB	8GB	12 months	60 months
MT500-22T-582T50-X-595	Specify when ordering	256GB	16GB	12 months	60 months
MT500-22T-582T50-X-5A5	Specify when ordering	512GB	16GB	12 months	60 months

*Extended Warranty available as a cost option, please enquire for prices at time of order. Extended Warranty must be ordered at time of purchase. Extended Warranty is a 48 month extension on top of the standard 12 months offered, to provide 60 months from date of first purchase.

MT500-22T - i7 PROCESSOR - STORAGE AND MEMORY CHOICE

Choose your performance spec based around the powerful Intel® i7 Core™ central processing unit.

Delivered ready to switch on, each Freeway Med-Tech AIO monitor/PC is pre-installed with an OS ready to enter your license details.

A standard warranty of 12 months from date of purchase covers any faulty components or workmanship with the option to extend this by an extra 48 months to 5 years in total from date of purchase.



! Please quote the correct part number opposite when ordering as all units are custom built.

MT500-22T with Intel® i7 Core™ CPU

21.5in Medical Cart Computer with capacitive touch LCD, Intel® 10th Gen i7 Core™ processor, medical grade AC/DC adapter. Supplied with 3 x MT202 Batteries.



Part Number	Operating System	Storage	RAM	Standard Warranty	Extended Warranty*
MT500-22T-582T70-X-495	Specify when ordering	256GB	8GB	12 months	60 months
MT500-22T-582T70-X-595	Specify when ordering	256GB	16GB	12 months	60 months
MT500-22T-582T70-X-5A5	Specify when ordering	512GB	16GB	12 months	60 months

*Extended Warranty available as a cost option, please enquire for prices at time of order. Extended Warranty must be ordered at time of purchase. Extended Warranty is a 48 month extension on top of the standard 12 months offered, to provide 60 months from date of first purchase.

MT500-22T - i9 PROCESSOR - STORAGE AND MEMORY CHOICE

Choose your performance spec based around the powerful Intel® i9 Core™ central processing unit.

Delivered ready to switch on, each Freeway Med-Tech AIO monitor/PC is pre-installed with an OS ready to enter your license details.

A standard warranty of 12 months from date of purchase covers any faulty components or workmanship with the option to extend this by an extra 48 months to 5 years in total from date of purchase.



! Please quote the correct part number opposite when ordering as all units are custom built.

MT500-22T with Intel® i9 Core™ CPU

21.5in Medical Cart Computer with capacitive touch LCD, Intel® 10th Gen i9 Core™ processor, medical grade AC/DC adapter. Supplied with 3 x MT202 Batteries.



Part Number	Operating System	Storage	RAM	Standard Warranty	Extended Warranty*
MT500-22T-582T90-X-495	Specify when ordering	256GB	8GB	12 months	60 months
MT500-22T-582T90-X-595	Specify when ordering	256GB	16GB	12 months	60 months
MT500-22T-582T90-X-5A5	Specify when ordering	512GB	16GB	12 months	60 months

*Extended Warranty available as a cost option, please enquire for prices at time of order. Extended Warranty must be ordered at time of purchase. Extended Warranty is a 48 month extension on top of the standard 12 months offered, to provide 60 months from date of first purchase.



MEDICAL AIO

BATTERY POWERED / 20IN



MT500-20T - AIO BATTERY POWERED 20IN MEDICAL PC

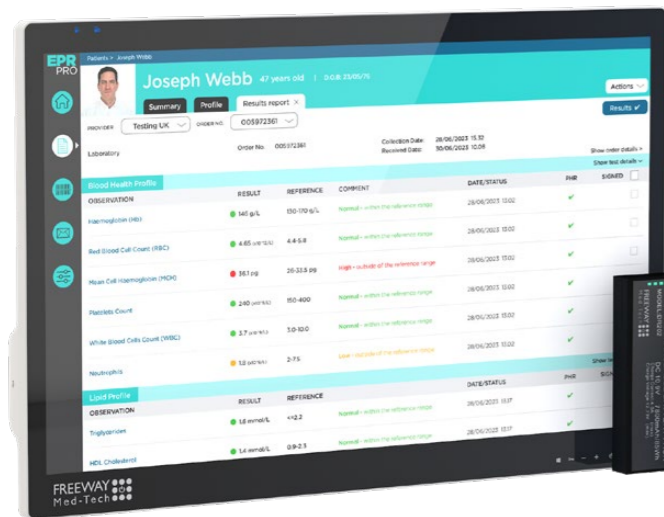

**NON-STOP
HOT-SWAPPABLE
POWER**



STATE-OF-THE-ART TOUCH SCREEN



10-point multi touch capacitive type screens as standard!

CHARGER DOCK (available separately)



(p. 212/3)

Charge up to 6 Li-ion battery packs simultaneously!

PRODUCT CODE

MT500-20T Battery powered 20in AIO touch screen medical grade monitor/PC

The Freeway Med-Tech MT500-20T Battery Powered All-In-One Monitor/PC offers fully mobile computing with its powerful, hot-swappable rechargeable battery packs. Options for 1 or 2 Lithium-ion batteries allow for either an emergency power back up, or totally wire-free operation. Also features a handy built-in reading light.

DIMENSIONS

Height = 295mm Width = 480mm Depth = 40.6mm

PRODUCT ELEVATIONS

Front

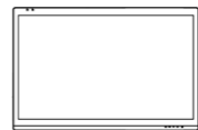

Side



KEY FEATURES

- Uses up to 2 Lithium-ion batteries for a full shift of mobile operation
- No need to be near mains power
- Intel Core-i5 and Core-i7 processors
- Runs Microsoft® Windows® / Linux / Igel
- High contrast 20" capacitive-type touch screen
- Slim fanless design
- UL60601 certified with anti-microbial enclosure
- Withstands common medical environment cleaning chemicals*

MT500-20T - AIO BATTERY POWERED 20IN MEDICAL PC

FRONT



REAR

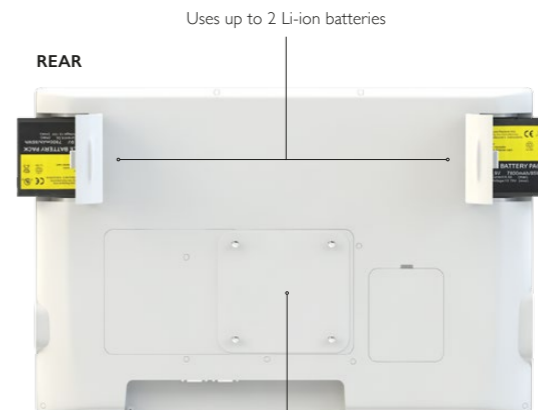

Water resistant enclosures

The screen and rear enclosure are IP rated against dust and moisture ingress, ensuring easy cleaning and disinfection*.

*See pages 228/9 for detailed information on cleaning chemicals and procedures.



Choice of processor

Modern Intel® Core-i7/9 range of processors to choose from.



Battery status made easy

Front facing LED battery indicators offer feedback on the health of each battery.

COMPREHENSIVE I/O†

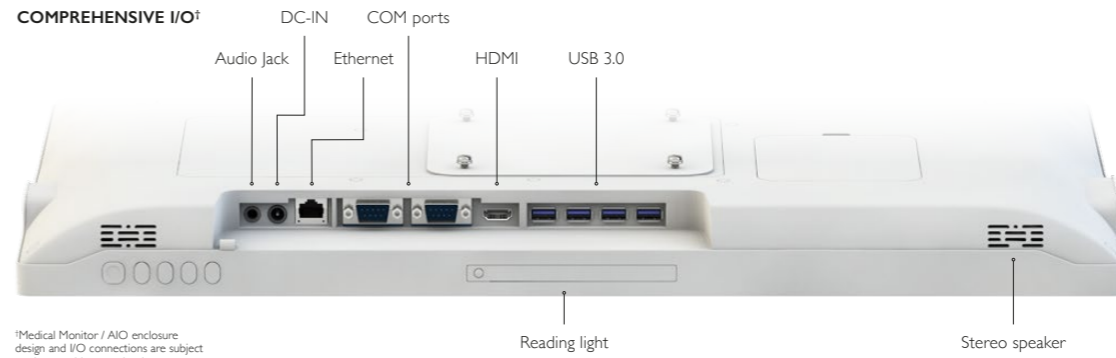

†Medical Monitor / AIO enclosure design and I/O connections are subject to change without notice. Image may look different to production models.



Easily hot-swap battery packs in a matter of seconds

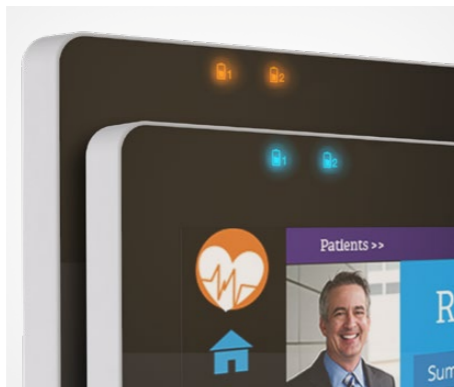

Clear battery status LEDs



Anti-microbial enclosure resists bacteria transmission



Moisture resistant medical-grade front panel

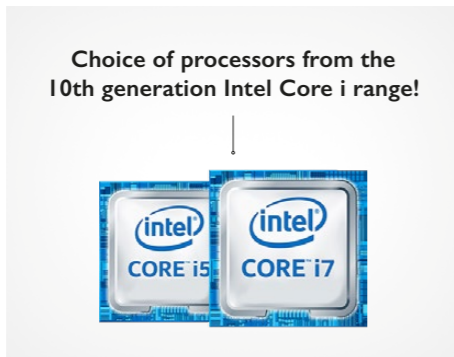

A choice of 6 to 8 cores of Intel® processing power.



Industry standard OS for medical software and systems.

TECHNICAL SPECIFICATIONS

System	
CPU	Intel® Core™ i5-10500T, 2.3 GHz (up to 3.8GHz) - 6 core Intel® Core™ i7-10700T, 2.0 GHz (up to 4.5GHz) - 8 core
RAM	8GB to 32GB
Storage	64Gb to 2TB Flash (mPCIe NVMe type SSD)
Operating System	Microsoft® Windows®/Linux/Igel - specify pre-install if required
Display	19.5in capacitive touch screen
Display resolution	1920x1080
Trusted platform module	TPM 2.0
Reading light	LED reading light x 1
Microphone and speaker	Built-in microphones and speaker
Network Interface	
WLAN	Ethernet 10/100/1000 MB Base-T LAN; Wi-Fi 802.11ax, 2.4GHz/5GHz dual band
Bluetooth	Bluetooth 5.1
I/O Ports	
USB Ports	USB 3.0 x 4 and USB 2.0 x 2
COM Port	2
HDMI-out (1.4a)	1
Audio Jack	1
Ethernet	RJ45 connector for ethernet x 1
DC-in	1
DC-out (optional)	N/A

Faster processors than our competitors!

Our Intel® Core i5 CPU is effectively 30% faster in real-world benchmark tests.



*For illustrative purposes only. Bacteria cannot be seen with the naked eye.

Mechanical/Environmental	
Fan/Fanless	Fanless
AC/DC Adaptor	Input: 100 – 240V AC; Output: 19V DC, 6.31A
Battery Pack	MT202 Li-ion battery; 90Wh, 8250mAh x 2 (optional)
Enclosure	ABS + PC plastics, anti-microbial enclosure
Dimensions (H x W x D)	295 x 480 x 40.6 mm
Weight	4.72kg (without battery) - 5.72kg (with 2 batteries)
VESA-compliant mounting	100mm x 100mm VESA standard
Water Resistance	Front panel: IP65; Enclosure: IPX2
Regulatory	ANSI/AAMI ES60601-1, IEC60601-1, IEC60601-1-2, FCC Part 18, FCC Part 15 Class B, GB 17625.1, GB 4943.1, GB/T 9254, CE-EMC, CE-RED, RCM, CCC
Major options	
Camera	5 megapixel front camera
NFC/RFID reader	N/A
Smart Card/CAC Reader	Full-slot, reads ISO 7816 T=0, T=1; 1.8/3/5V smart card



MT500-20T ACCESSORIES (available separately)



MT500-20T - PENTIUM™ PROCESSOR - STORAGE AND MEMORY CHOICE

Choose your performance spec based around the Intel® Pentium™ central processing unit.

Delivered ready to switch on, each Freeway Med-Tech AIO monitor/PC is pre-installed with an OS ready to enter your license details.

A standard warranty of 12 months from date of purchase covers any faulty components or workmanship with the option to extend this by an extra 48 months to 5 years in total from date of purchase.



! Please quote the correct part number opposite when ordering as all units are custom built.

MT500-20T with Intel® Pentium™ CPU

19.5in Medical Cart Computer with capacitive touch LCD, Intel® 10th Gen Pentium™ processor, medical grade AC/DC adapter.



Part Number	Operating System	Storage	RAM	Standard Warranty	Extended Warranty*
MT500-20T-581TP0-X-495	Specify when ordering	256GB	8GB	12 months	60 months
MT500-20T-581TP0-X-595	Specify when ordering	256GB	16GB	12 months	60 months
MT500-20T-581TP0-X-5A5	Specify when ordering	512GB	16GB	12 months	60 months

*Extended Warranty available as a cost option, please enquire for prices at time of order. Extended Warranty must be ordered at time of purchase. Extended Warranty is a 48 month extension on top of the standard 12 months offered, to provide 60 months from date of first purchase.

MT500-20T - i5 PROCESSOR - STORAGE AND MEMORY CHOICE

Choose your performance spec based around the powerful Intel® i5 Core™ central processing unit.

Delivered ready to switch on, each Freeway Med-Tech AIO monitor/PC is pre-installed with an OS ready to enter your license details.

A standard warranty of 12 months from date of purchase covers any faulty components or workmanship with the option to extend this by an extra 48 months to 5 years in total from date of purchase.



! Please quote the correct part number opposite when ordering as all units are custom built.

MT500-20T with Intel® i5 Core™ CPU

19.5in Medical Cart Computer with capacitive touch LCD, Intel® 10th Gen i5 Core™ processor, medical grade AC/DC adapter.



Part Number	Operating System	Storage	RAM	Standard Warranty	Extended Warranty*
MT500-20T-581T50-X-495	Specify when ordering	256GB	8GB	12 months	60 months
MT500-20T-581T50-X-595	Specify when ordering	256GB	16GB	12 months	60 months
MT500-20T-581T50-X-5A5	Specify when ordering	512GB	16GB	12 months	60 months

*Extended Warranty available as a cost option, please enquire for prices at time of order. Extended Warranty must be ordered at time of purchase. Extended Warranty is a 48 month extension on top of the standard 12 months offered, to provide 60 months from date of first purchase.

MT500-20T - i7 PROCESSOR - STORAGE AND MEMORY CHOICE

Choose your performance spec based around the powerful Intel® i7 Core™ central processing unit.

Delivered ready to switch on, each Freeway Med-Tech AIO monitor/PC is pre-installed with an OS ready to enter your license details.

A standard warranty of 12 months from date of purchase covers any faulty components or workmanship with the option to extend this by an extra 48 months to 5 years in total from date of purchase.



⚠ Please quote the correct part number opposite when ordering as all units are custom built.

MT500-20T with Intel® i7 Core™ CPU

19.5in Medical Cart Computer with capacitive touch LCD, Intel® 10th Gen i7 Core™ processor, medical grade AC/DC adapter. Supplied with 2 x MT202 Batteries.



Part Number	Operating System	Storage	RAM	Standard Warranty	Extended Warranty*
MT500-20T-581T70-X-495	Specify when ordering	256GB	8GB	12 months	60 months
MT500-20T-581T70-X-595	Specify when ordering	256GB	16GB	12 months	60 months
MT500-20T-581T70-X-5A5	Specify when ordering	512GB	16GB	12 months	60 months

*Extended Warranty available as a cost option, please enquire for prices at time of order. Extended Warranty must be ordered at time of purchase. Extended Warranty is a 48 month extension on top of the standard 12 months offered, to provide 60 months from date of first purchase.





MEDICAL AIO

MAINS POWERED / 24IN

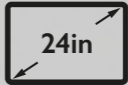

MT400-24T - AIO MAINS POWERED 24IN MEDICAL PC

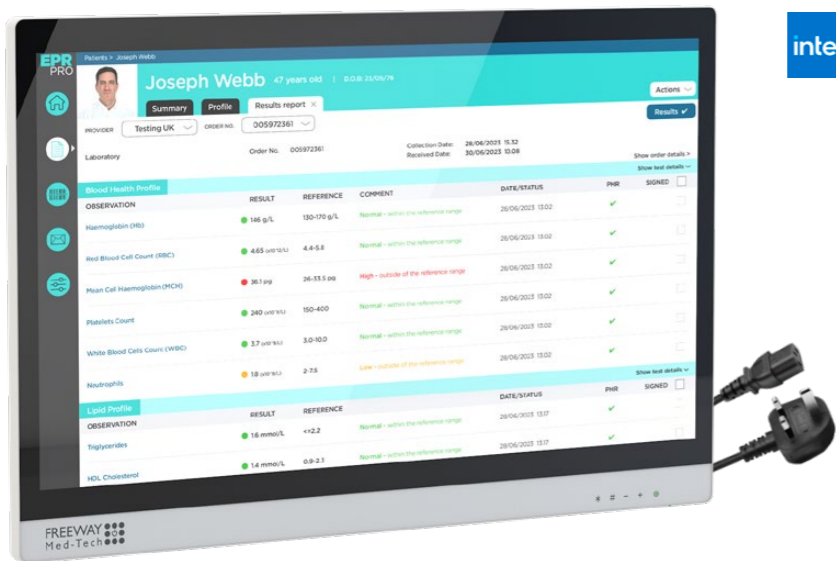

STATE-OF-THE-ART TOUCH SCREEN



10-point multi touch capacitive type screens as standard!

MAINS POWERED (iWOW required to be plugged-in)



PRODUCT CODE

MT400-24T Mains powered 24in AIO touch screen medical grade PC

The Freeway Med-Tech MT400-24T Mains Powered All-In-One Monitor/PC offers the same technical specification and features as our battery powered AIO model, just with the need for a permanent 240V mains supply. For use where an iWOW will be predominately used in a fixed location.

DIMENSIONS

Height = **370.9mm** Width = **564.4mm** Depth = **41.2mm**

PRODUCT ELEVATIONS

Front

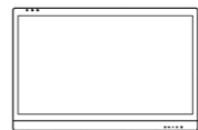

W

H

Side



D

KEY FEATURES

- Intel Core-i5/7/9 processors
- Runs Microsoft® Windows® / Linux / Igel
- High contrast 24" capacitive-type touch screen
- Slim fanless design
- UL60601 certified with anti-microbial enclosure
- Withstands common medical environment cleaning chemicals*

MT400-24T - AIO MAINS POWERED 24IN MEDICAL PC

FRONT



REAR



100x100 VESA mounting

COMPREHENSIVE I/O†

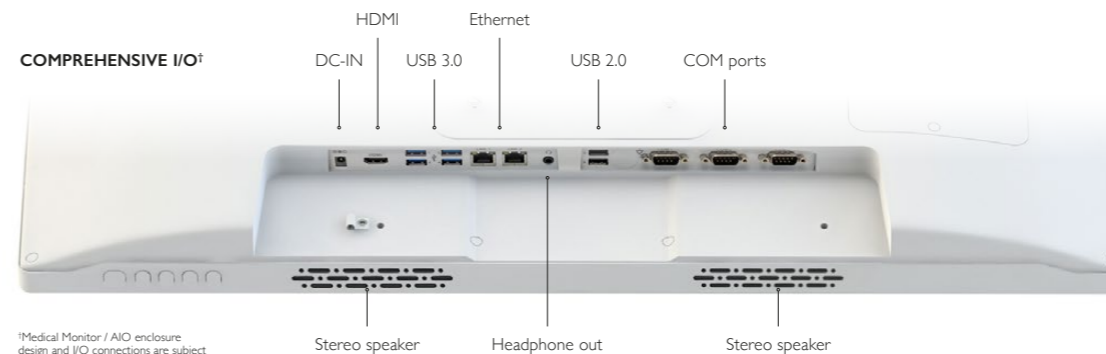

†Medical Monitor / AIO enclosure design and I/O connections are subject to change without notice. Image may look different to production models.

FREEWAY
Med-Tech



Water resistant enclosures

The screen and rear enclosure are IP rated against dust and moisture ingress, ensuring easy cleaning and disinfection*.

*See pages 228/9 for detailed information on cleaning chemicals and procedures.



Choice of processor

Modern Intel Core-i5/7/9 range of processors to choose from.



Mains powered

Requires a permanent 240V mains outlet for use.



Anti-microbial enclosure resists bacteria transmission



Moisture resistant medical-grade front panel

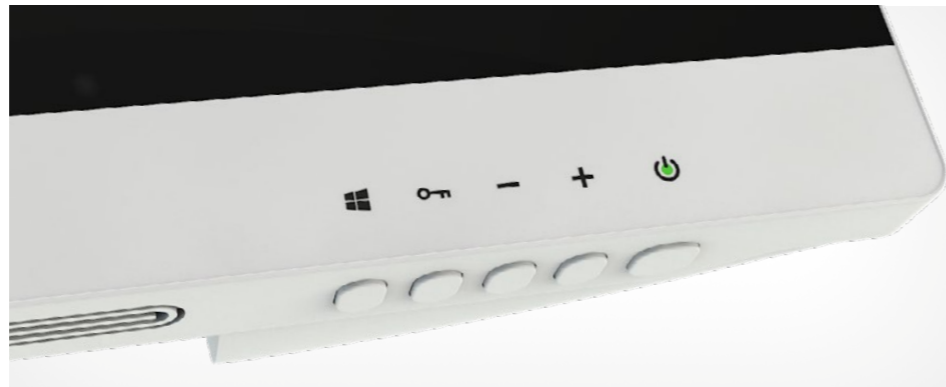

Built-in speakers and clear easy-to-use function buttons located on the underside of the monitor

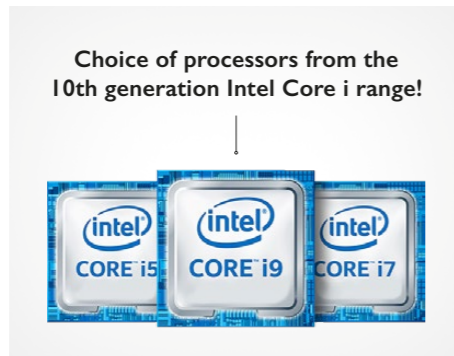

A choice of 6 to 10 cores of Intel processing power:



Industry standard OS for medical software and systems.

*For illustrative purposes only. Bacteria cannot be seen with the naked eye.

TECHNICAL SPECIFICATIONS

System	
CPU	Intel® Core™ i5-10500T, 2.3 GHz (up to 3.8GHz) - 6 core Intel® Core™ i7-10700T, 2.0 GHz (up to 4.5GHz) - 8 core Intel® Core™ i9-10900T, 1.9 GHz (up to 4.6GHz) - 10 core
RAM	8GB to 64GB
Storage	256Gb to 4TB Flash (mPCIe NVMe type SSD)
Operating System	Microsoft® Windows®/Linux/Igel - specify pre-install if required
Display	23.8in capacitive touch screen
Display resolution	1920x1080
Trusted platform module	TPM 2.0
Battery Pack	Optional integrated UPS battery x 1
Buttons	1 power and 4 programmable buttons
Microphone and speaker	Built-in microphones and speaker
Network Interface	
WLAN	Wi-Fi 802.11ax, 2.4GHz/5GHz dual band
Bluetooth	Bluetooth 5.1 LE
I/O Ports	
USB Ports	USB 3.0 x 4 (ESD protection: ±17KV by air; ±12KV by contact) USB 2.0 x 2 (ESD protection: ±18KV by air; ±12KV by contact)
COM Port	3
HDMI-out (1.4a)	1 (ESD protection: ±17KV by air; ±12KV by contact)
Audio Jack	1
Ethernet	RJ45 connector x 2 (ESD protection: ±30KV by air; ±30KV by contact)
DC-in	1
Potential Equalization Conductor	1 (optional)

Mechanical/Environmental	
Fan/Fanless	Fanless
AC/DC Adaptor	Input: 100 – 240V AC; Output: 19V DC, 6.31A
Enclosure	Aluminum alloy, antimicrobial enclosure
Dimensions (H x W x D)	370.9 x 564.4 x 41.2mm
Weight	8kg
VESA-compliant mounting	100mm x 100mm VESA standard
Water Resistance	Front panel: IP65; Enclosure: IPX2
Regulatory	ANSI/AAMI ES60601-1, IEC60601-1, IEC60601-1-2, FCC Part 18, FCC Part 15 Class B, GB 17625.1, GB 4943.1, GB/T 9254, CE-EMC, CE-RED, Energy Star 8.0, RCM, CCC
Major options	
Camera	Full-HD front camera
NFC/RFID reader	HF 13.56MHz, ISO standard 15693, 14443A(B) & 18000-3 mode-1, or dual frequency, reads both 125KHz and 13.56MHz credentials
Smart Card/CAC Reader	Full-slot, reads ISO 7816 T=0, T=1; 1.8/3/5V smart card

Intel® WiFi Series 6 Module as standard ✓

Optional Imprivata-compatible RFID reader module ✓

Optional HID Smart Card Reader ✓

Faster processors than our competitors!

Our Intel® Core i5 CPU is effectively 30% faster in real-world benchmark tests.



MT400-24T - PENTIUM™ PROCESSOR - STORAGE AND MEMORY CHOICE

Choose your performance spec based around the Intel® Pentium™ central processing unit.

Delivered ready to switch on, each Freeway Med-Tech AIO monitor/PC is pre-installed with an OS ready to enter your license details.

A standard warranty of 12 months from date of purchase covers any faulty components or workmanship with the option to extend this by an extra 48 months to 5 years in total from date of purchase.



Please quote the correct part number opposite when ordering as all units are custom built.

MT400-24T with Intel® Pentium™ CPU

23.6in Medical Cart Computer with capacitive touch LCD, Intel® 10th Gen Pentium™ processor, medical grade AC/DC adapter.



Part Number	Operating System	Storage	RAM	Standard Warranty	Extended Warranty*
MT400-24T-504TP-X-C495	Specify when ordering	256GB	8GB	12 months	60 months
MT400-24T-504TP-X-C595	Specify when ordering	256GB	16GB	12 months	60 months
MT400-24T-504TP-X-C5A5	Specify when ordering	512GB	16GB	12 months	60 months

*Extended Warranty available as a cost option, please enquire for prices at time of order. Extended Warranty must be ordered at time of purchase. Extended Warranty is a 48 month extension on top of the standard 12 months offered, to provide 60 months from date of first purchase.

MT400-24T - i5 PROCESSOR - STORAGE AND MEMORY CHOICE

Choose your performance spec based around the powerful Intel® i5 Core™ central processing unit.

Delivered ready to switch on, each Freeway Med-Tech AIO monitor/PC is pre-installed with an OS ready to enter your license details.

A standard warranty of 12 months from date of purchase covers any faulty components or workmanship with the option to extend this by an extra 48 months to 5 years in total from date of purchase.



Please quote the correct part number opposite when ordering as all units are custom built.

MT400-24T with Intel® i5 Core™ CPU

23.6in Medical Cart Computer with capacitive touch LCD, Intel® 10th Gen i5 Core™ processor, medical grade AC/DC adapter.



Part Number	Operating System	Storage	RAM	Standard Warranty	Extended Warranty*
MT400-24T-504T5-X-C495	Specify when ordering	256GB	8GB	12 months	60 months
MT400-24T-504T5-X-C595	Specify when ordering	256GB	16GB	12 months	60 months
MT400-24T-504T5-X-C5A5	Specify when ordering	512GB	16GB	12 months	60 months

*Extended Warranty available as a cost option, please enquire for prices at time of order. Extended Warranty must be ordered at time of purchase. Extended Warranty is a 48 month extension on top of the standard 12 months offered, to provide 60 months from date of first purchase.

MT400-24T - i7 PROCESSOR - STORAGE AND MEMORY CHOICE

Choose your performance spec based around the powerful Intel® i7 Core™ central processing unit.

Delivered ready to switch on, each Freeway Med-Tech AIO monitor/PC is pre-installed with an OS ready to enter your license details.

A standard warranty of 12 months from date of purchase covers any faulty components or workmanship with the option to extend this by an extra 48 months to 5 years in total from date of purchase.



Please quote the correct part number opposite when ordering as all units are custom built.

MT400-24T with Intel® i7 Core™ CPU

23.6in Medical Cart Computer with capacitive touch LCD, Intel® 10th Gen i7 Core™ processor, medical grade AC/DC adapter.



Part Number	Operating System	Storage	RAM	Standard Warranty	Extended Warranty*
MT400-24T-504T7-X-C495	Specify when ordering	256GB	8GB	12 months	60 months
MT400-24T-504T7-X-C595	Specify when ordering	256GB	16GB	12 months	60 months
MT400-24T-504T7-X-C5A5	Specify when ordering	512GB	16GB	12 months	60 months

*Extended Warranty available as a cost option, please enquire for prices at time of order. Extended Warranty must be ordered at time of purchase. Extended Warranty is a 48 month extension on top of the standard 12 months offered, to provide 60 months from date of first purchase.

MT400-24T - i9 PROCESSOR - STORAGE AND MEMORY CHOICE

Choose your performance spec based around the powerful Intel® i9 Core™ central processing unit.

Delivered ready to switch on, each Freeway Med-Tech AIO monitor/PC is pre-installed with an OS ready to enter your license details.

A standard warranty of 12 months from date of purchase covers any faulty components or workmanship with the option to extend this by an extra 48 months to 5 years in total from date of purchase.



Please quote the correct part number opposite when ordering as all units are custom built.

MT400-24T with Intel® i9 Core™ CPU

23.6in Medical Cart Computer with capacitive touch LCD, Intel® 10th Gen i9 Core™ processor, medical grade AC/DC adapter.



Part Number	Operating System	Storage	RAM	Standard Warranty	Extended Warranty*
MT400-24T-504T9-X-C495	Specify when ordering	256GB	8GB	12 months	60 months
MT400-24T-504T9-X-C595	Specify when ordering	256GB	16GB	12 months	60 months
MT400-24T-504T9-X-C5A5	Specify when ordering	512GB	16GB	12 months	60 months

*Extended Warranty available as a cost option, please enquire for prices at time of order. Extended Warranty must be ordered at time of purchase. Extended Warranty is a 48 month extension on top of the standard 12 months offered, to provide 60 months from date of first purchase.



MEDICAL AIO

MAINS POWERED / 27IN

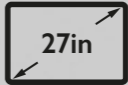

MT400-27T - AIO MAINS POWERED 27IN MEDICAL PC

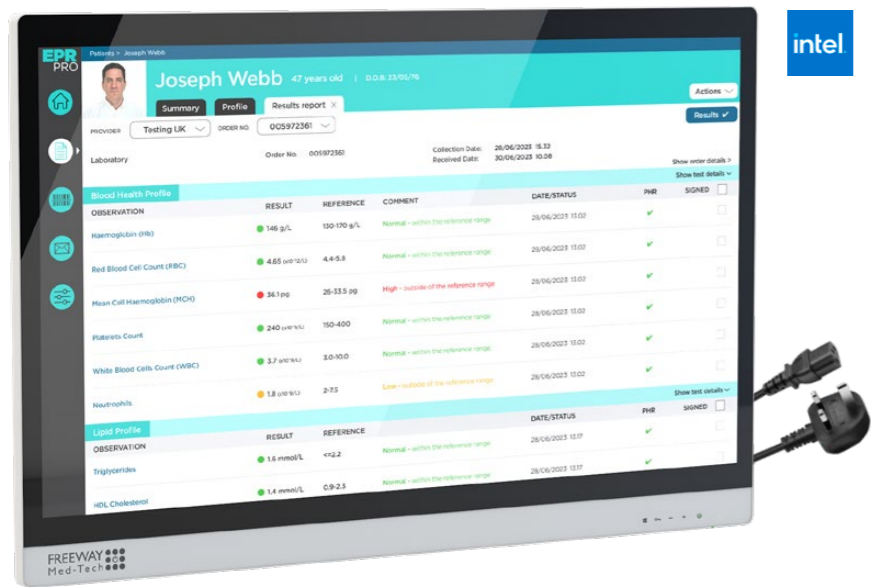

STATE-OF-THE-ART TOUCH SCREEN



10-point multi touch capacitive type screens as standard!

MAINS POWERED (iWOW required to be plugged-in)



PRODUCT CODE

MT400-27T Mains powered 27in AIO touch screen medical grade PC

The Freeway Med-Tech MT400-27T Mains Powered All-In-One Monitor/PC offers the same technical specification and features as our battery powered AIO model, just with the need for a permanent 240V mains supply. For use where an iWOW will be predominately used in a fixed location.

DIMENSIONS

Height = 411.8mm Width = 639.1mm Depth = 45mm

PRODUCT ELEVATIONS

Front



W

Side



D

KEY FEATURES

- Intel Core-i5/7/9 processors
- Runs Microsoft® Windows® / Linux / Igel
- High contrast 27" capacitive-type touch screen
- Slim fanless design
- UL60601 certified with anti-microbial enclosure
- Withstands common medical environment cleaning chemicals*

MT400-27T - AIO MAINS POWERED 27IN MEDICAL PC

FRONT



REAR



100x100 VESA mounting

COMPREHENSIVE I/O†

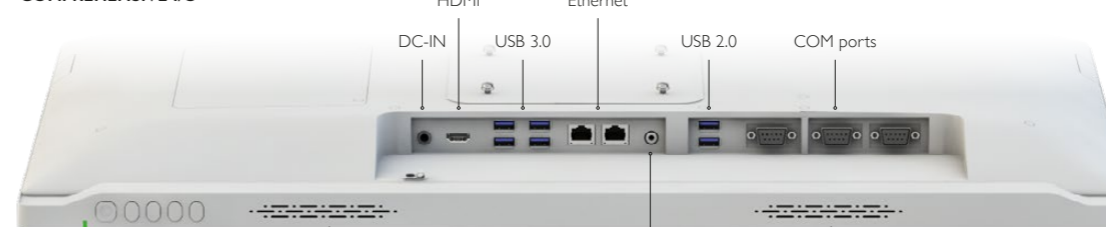

†Medical Monitor / AIO enclosure design and I/O connections are subject to change without notice. Image may look different to production models.

Stereo speaker

Headphone out

Stereo speaker



Water resistant enclosures

The screen and rear enclosure are IP rated against dust and moisture ingress, ensuring easy cleaning and disinfection*.

*See pages 228/9 for detailed information on cleaning chemicals and procedures.



Choice of processor

Modern Intel Core-i5/7/9 range of processors to choose from.



Mains powered

Requires a permanent 240V mains outlet for use.

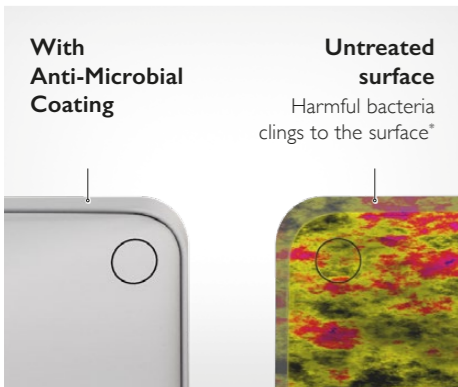

Anti-microbial enclosure resists bacteria transmission

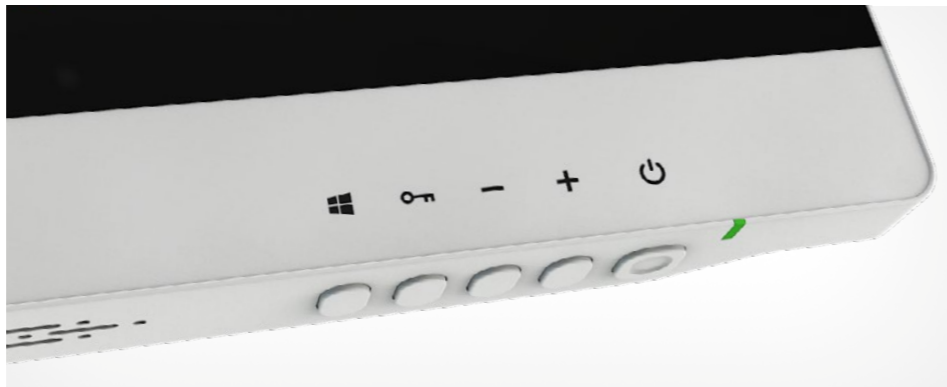

Built-in speakers and clear easy-to-use function buttons located on the underside of the monitor



Moisture resistant medical-grade front panel

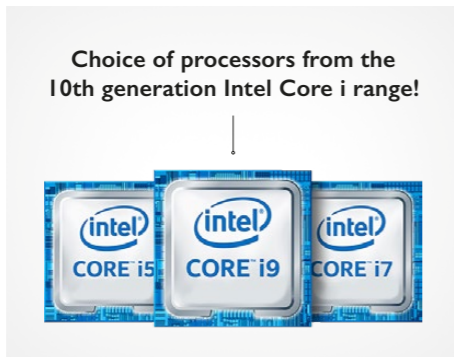

A choice of 6 to 10 cores of Intel processing power.



Industry standard OS for medical software and systems.

*For illustrative purposes only. Bacteria cannot be seen with the naked eye.

TECHNICAL SPECIFICATIONS

System		
CPU	Intel® Core™ i5-10500T, 2.3 GHz (up to 3.8GHz) - 6 core Intel® Core™ i7-10700T, 2.0 GHz (up to 4.5GHz) - 8 core Intel® Core™ i9-10900T, 1.9 GHz (up to 4.6GHz) - 10 core	
RAM	8GB to 64GB	
Storage	256Gb to 4TB Flash (mPCIe NVMe type SSD)	
Operating System	Microsoft® Windows®/Linux/Igel - specify pre-install if required	
Display	27in capacitive touch screen	
Display resolution	1920x1080 (optional 3840x2160)	
Trusted platform module	TPM 2.0	
Battery Pack	Optional integrated UPS battery x 1	
Buttons	1 power and 4 programmable buttons	
Microphone and speaker	Built-in microphones and speaker	
Network Interface		
WLAN	Wi-Fi 802.11ax, 2.4GHz/5GHz dual band	
Bluetooth	Bluetooth 5.1 LE	
I/O Ports		
USB Ports	USB 3.0 x 4 (ESD protection: ±17KV by air; ±12KV by contact) USB 2.0 x 2 (ESD protection: ±18KV by air; ±12KV by contact)	
COM Port	3	
HDMI-out (1.4a)	1 (ESD protection: ±17KV by air; ±12KV by contact)	
Audio Jack	1	
Ethernet	RJ45 connector x 2 (ESD protection: ±30KV by air; ±30KV by contact)	
DC-in	1	
Potential Equalization Conductor	1 (optional)	

Mechanical/Environmental	
Fan/Fanless	Fanless
AC/DC Adaptor	Input: 100 – 240V AC; Output: 19V DC, 6.31A
Enclosure	Aluminum alloy, antimicrobial enclosure
Dimensions (H x W x D)	411.8 x 639.1 x 45mm
Weight	10.5kg
VESA-compliant mounting	100mm x 100mm VESA standard
Water Resistance	Front panel: IP65; Enclosure: IPX2
Regulatory	ANSI/AAMI ES60601-1, IEC60601-1, IEC60601-1-2, FCC Part 18, FCC Part 15 Class B, GB 17625.1, GB 4943.1, GB/T 9254, CE-EMC, CE-RED, Energy Star 8.0, RCM, CCC
Major options	
Camera	Full-HD front camera
NFC/RFID reader	HF 13.56MHz, ISO standard 15693, 14443A(B) & 18000-3 mode-1, or dual frequency, reads both 125KHz and 13.56MHz credentials
Smart Card/CAC Reader	Full-slot, reads ISO 7816 T=0, T=1; 1.8/3/5V smart card

Faster processors than our competitors!

Our Intel® Core i5 CPU is effectively 30% faster in real-world benchmark tests.



MT400-27T - PENTIUM™ PROCESSOR - STORAGE AND MEMORY CHOICE

Choose your performance spec based around the Intel® Pentium™ central processing unit.

Delivered ready to switch on, each Freeway Med-Tech AIO monitor/PC is pre-installed with an OS ready to enter your license details.

A standard warranty of 12 months from date of purchase covers any faulty components or workmanship with the option to extend this by an extra 48 months to 5 years in total from date of purchase.



Please quote the correct part number opposite when ordering as all units are custom built.

MT400-27T with Intel® Pentium™ CPU

27in Medical Cart Computer with capacitive touch LCD, Intel® 10th Gen Pentium™ processor, medical grade AC/DC adapter.



Part Number	Operating System	Storage	RAM	Standard Warranty	Extended Warranty*
MT400-27T-507TP-X-C495	Specify when ordering	256GB	8GB	12 months	60 months
MT400-27T-507TP-X-C595	Specify when ordering	256GB	16GB	12 months	60 months
MT400-27T-507TP-X-C5A5	Specify when ordering	512GB	16GB	12 months	60 months

*Extended Warranty available as a cost option, please enquire for prices at time of order. Extended Warranty must be ordered at time of purchase. Extended Warranty is a 48 month extension on top of the standard 12 months offered, to provide 60 months from date of first purchase.

MT400-27T - i5 PROCESSOR - STORAGE AND MEMORY CHOICE

Choose your performance spec based around the powerful Intel® i5 Core™ central processing unit.

Delivered ready to switch on, each Freeway Med-Tech AIO monitor/PC is pre-installed with an OS ready to enter your license details.

A standard warranty of 12 months from date of purchase covers any faulty components or workmanship with the option to extend this by an extra 48 months to 5 years in total from date of purchase.



Please quote the correct part number opposite when ordering as all units are custom built.

MT400-27T with Intel® i5 Core™ CPU

27in Medical Cart Computer with capacitive touch LCD, Intel® 10th Gen i5 Core™ processor, medical grade AC/DC adapter.



Part Number	Operating System	Storage	RAM	Standard Warranty	Extended Warranty*
MT400-27T-507T5-X-C495	Specify when ordering	256GB	8GB	12 months	60 months
MT400-27T-507T5-X-C595	Specify when ordering	256GB	16GB	12 months	60 months
MT400-27T-507T5-X-C5A5	Specify when ordering	512GB	16GB	12 months	60 months

*Extended Warranty available as a cost option, please enquire for prices at time of order. Extended Warranty must be ordered at time of purchase. Extended Warranty is a 48 month extension on top of the standard 12 months offered, to provide 60 months from date of first purchase.

MT400-27T - i7 PROCESSOR - STORAGE AND MEMORY CHOICE

Choose your performance spec based around the powerful Intel® i7 Core™ central processing unit.

Delivered ready to switch on, each Freeway Med-Tech AIO monitor/PC is pre-installed with an OS ready to enter your license details.

A standard warranty of 12 months from date of purchase covers any faulty components or workmanship with the option to extend this by an extra 48 months to 5 years in total from date of purchase.



Please quote the correct part number opposite when ordering as all units are custom built.

MT400-27T with Intel® i7 Core™ CPU

27in Medical Cart Computer with capacitive touch LCD, Intel® 10th Gen i7 Core™ processor, medical grade AC/DC adapter.



Part Number	Operating System	Storage	RAM	Standard Warranty	Extended Warranty*
MT400-27T-507T7-X-C495	Specify when ordering	256GB	8GB	12 months	60 months
MT400-27T-507T7-X-C595	Specify when ordering	256GB	16GB	12 months	60 months
MT400-27T-507T7-X-C5A5	Specify when ordering	512GB	16GB	12 months	60 months

*Extended Warranty available as a cost option, please enquire for prices at time of order. Extended Warranty must be ordered at time of purchase. Extended Warranty is a 48 month extension on top of the standard 12 months offered, to provide 60 months from date of first purchase.

MT400-27T - i9 PROCESSOR - STORAGE AND MEMORY CHOICE

Choose your performance spec based around the powerful Intel® i9 Core™ central processing unit.

Delivered ready to switch on, each Freeway Med-Tech AIO monitor/PC is pre-installed with an OS ready to enter your license details.

A standard warranty of 12 months from date of purchase covers any faulty components or workmanship with the option to extend this by an extra 48 months to 5 years in total from date of purchase.



Please quote the correct part number opposite when ordering as all units are custom built.

MT400-27T with Intel® i9 Core™ CPU

27in Medical Cart Computer with capacitive touch LCD, Intel® 10th Gen i9 Core™ processor, medical grade AC/DC adapter.



Part Number	Operating System	Storage	RAM	Standard Warranty	Extended Warranty*
MT400-27T-507T9-X-C495	Specify when ordering	256GB	8GB	12 months	60 months
MT400-27T-507T9-X-C595	Specify when ordering	256GB	16GB	12 months	60 months
MT400-27T-507T9-X-C5A5	Specify when ordering	512GB	16GB	12 months	60 months

*Extended Warranty available as a cost option, please enquire for prices at time of order. Extended Warranty must be ordered at time of purchase. Extended Warranty is a 48 month extension on top of the standard 12 months offered, to provide 60 months from date of first purchase.



MEDICAL TABLET

BATTERY POWERED / 13IN



MT300-13T - RUGGED 2 IN 1 MEDICAL TABLET PC



**NON-STOP
HOT-SWAPPABLE
POWER**

BACKLIT KEYBOARD (available separately)

(p.222/3)



DESKTOP CRADLE (available separately)

(p.224/5)



Dock the tablet to utilise full-size monitors and keyboards!

PRODUCT CODE

MT300-13T Rugged 2 in 1 Battery powered 13in medical tablet PC

The Freeway Med-Tech Medical Tablet features a brilliant 13.3" capacitive touch screen and a 11th generation Intel® Core™ i series processor within a slim, durable package. With built-in front/back cameras and Wi-Fi as well as optional barcode scanner & integrated RFID, this robust tablet offers health professionals an effective tool to monitor, record and retrieve patient information.

DIMENSIONS

Height = 256mm Width = 335mm Depth = 21mm

PRODUCT ELEVATIONS

Front

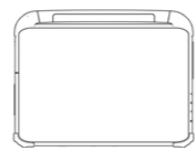

W

H

Side



D

Rear Stand



KEY FEATURES

- 13.3in Full HD LCD display with capacitive touch and support for optional digital pen
- 11th generation Intel® Core™ i series processors
- Compatible with Windows®, Linux and other operating systems
- Built-in front and back cameras
- Optional built-in 2D barcode scanner
- High capacity hot-swappable battery pack
- Foldable tabletop stand and optional integrated handle
- UL60601 certified with anti-microbial enclosure
- Withstands common medical environment cleaning chemicals*

MT300-13T - RUGGED 2 IN 1 MEDICAL TABLET PC

FRONT



REAR

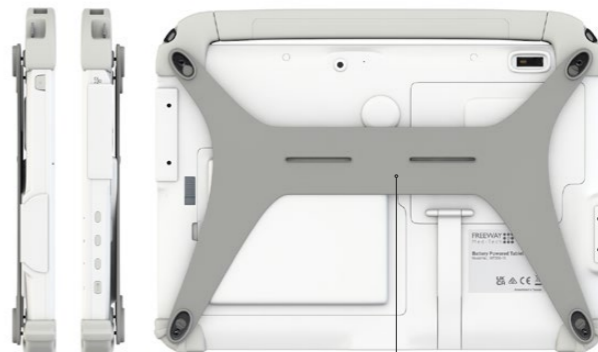

Removable silicone hand strap (optional)

COMPREHENSIVE I/O*

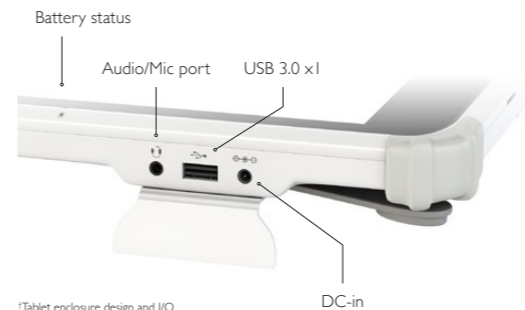

*Tablet enclosure design and I/O connections are subject to change without notice.

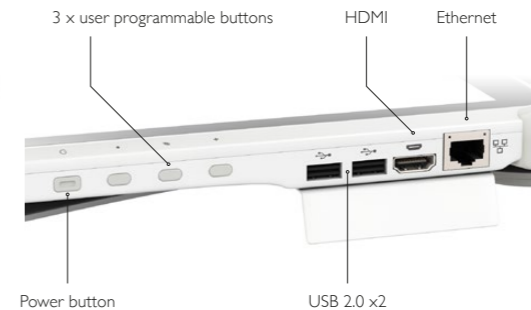

FREWAY
Med-Tech



Front and back cameras

Full-HD front camera and 8 megapixel back camera!



Barcode scanning

Optional built-in 2D scanner available when ordering (also reads 1D).



Rugged protection

Corner bumpers help eliminate unwanted accidental damage.



Powerful Intel® Core i

11th generation quad core i5 and i7 processor options in a tablet!



Handy stand enables laptop type use with removable keyboard



With Anti-Microbial Coating

Untreated surface

Harmful bacteria clings to the surface*

Anti-microbial enclosure resists bacteria transmission

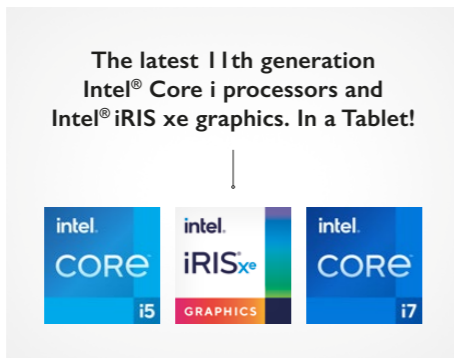

A choice of Intel's latest 11th gen processing power.



User-programmable buttons

Quick one-touch operation - an example would be Privacy setup, where the screen could be immediately switched off via a single button press.

Physical buttons that are user-programmable for quick actions.



Industry standard OS for medical software and systems.

*For illustrative purposes only. Bacteria cannot be seen with the naked eye.

TECHNICAL SPECIFICATIONS

System		intel
CPU	Intel® Core™ i5-1135G7, up to 4.2GHz - 4 core Intel® Core™ i7-1165G7, up to 4.7GHz - 4 core	
RAM	8GB to 32GB	
Storage	256Gb to 2TB Flash	
Operating System	Microsoft® Windows® 10 IoT Enterprise or Ubuntu	
Display	13.3in high brightness capacitive touch screen	
Display resolution	1920x1080	
Camera	Full-HD front camera and 8 megapixel back camera	
Microphone and speaker	Built-in microphone and speaker	
Network Interface		
WLAN	Wi-Fi 802.11ax, 2.4GHz/5GHz dual band	
I/O Ports		
USB Ports	USB 3.0 x 1, USB 2.0 x 2	
HDMI-out	1	
Headset Jack	1 (3.5mm)	
Ethernet	RJ45 connector for ethernet x 1	
DC-in	1	

Mechanical/Environmental		
Fan/Fanless	Fanless	
AC/DC Adaptor	Input: 100 – 240V AC; Output: 19V DC, 3.42A	
Battery Pack	Hot swappable battery, 5400mAh	
Enclosure	ABS + PC plastics and magnesium-aluminum alloy; antimicrobial enclosure	
Dimensions (H x W x D)	256 x 335 x 21 mm	
Weight	1.8kg	
Regulatory	FCC/IC, CE/CB, RCM, CCC, ANSI/AAMI ES60601-1	
Major options		
Barcode Scanner	2D scanner; reads 1D also	

MT300-13T ACCESSORIES (available separately)



CALL US NOW FOR MORE INFO ON 01635 866717 OR EMAIL SALES@FREEWAYMEDTECH.COM

RELATED PRODUCT



(p.82-87)

iWOW® Duo
Tablet docking cart

IS IT REALLY A TABLET?

Time to re-think...

Most assume that a tablet is an add-on, an extra, but not a replacement for a laptop or desktop PC. Well, think again.

The MT300-13T is as powerful as the latest laptops and when combined with the desktop cradle, a match for most standalone PCs!



- Powerful 11th gen Intel® Core i processors
- The latest Intel® on-chip graphics - iRIS Xe
- Comprehensive I/O
- Runs as a dual or an extended screen setup when mounted in the optional desktop cradle

The portability of a tablet, the power of the latest laptop technology!

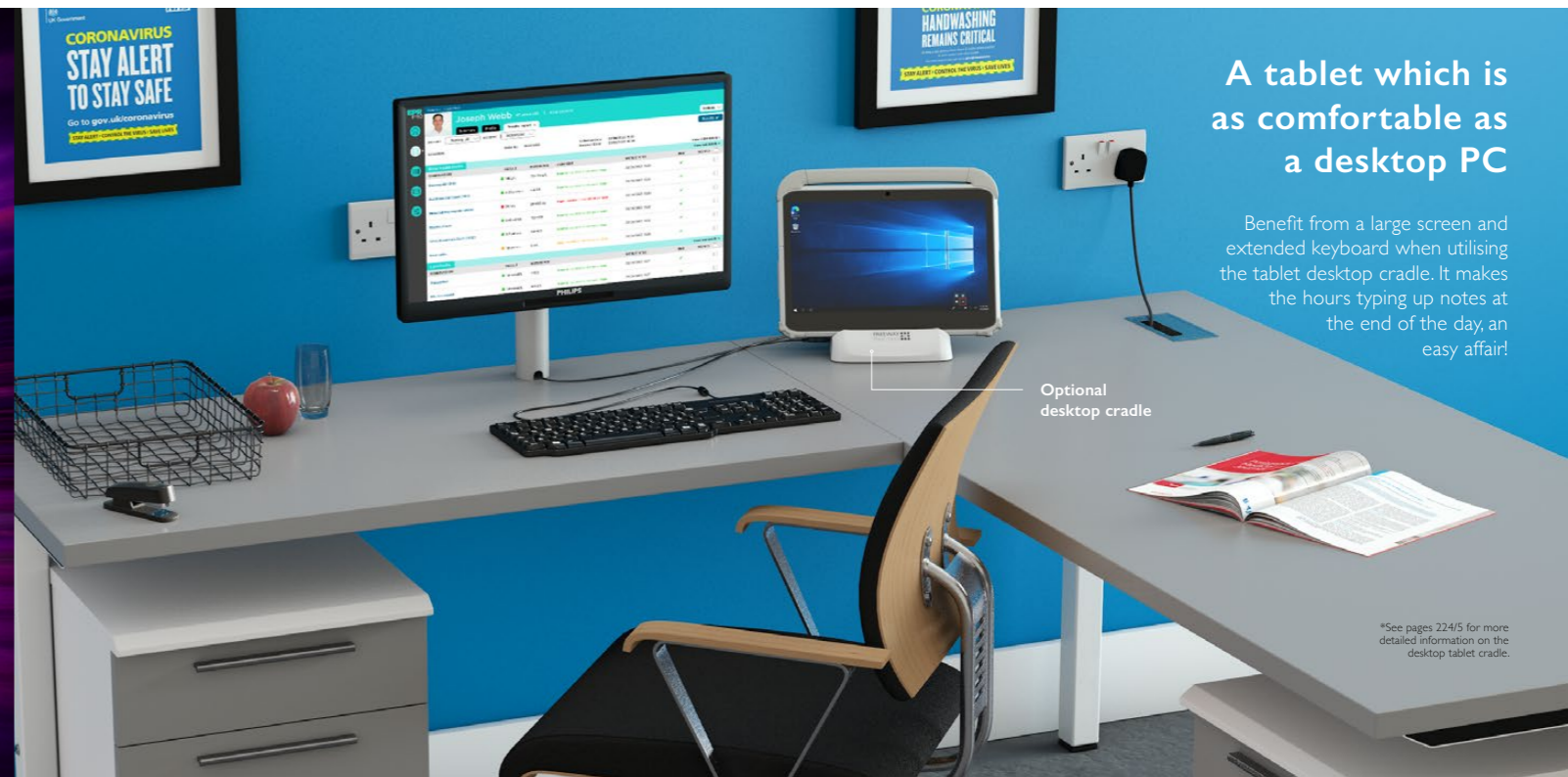

A tablet which is as comfortable as a desktop PC

Benefit from a large screen and extended keyboard when utilising the tablet desktop cradle. It makes the hours typing up notes at the end of the day, an easy affair!

Optional desktop cradle

*See pages 224/5 for more detailed information on the desktop tablet cradle.

EASY SCANNING

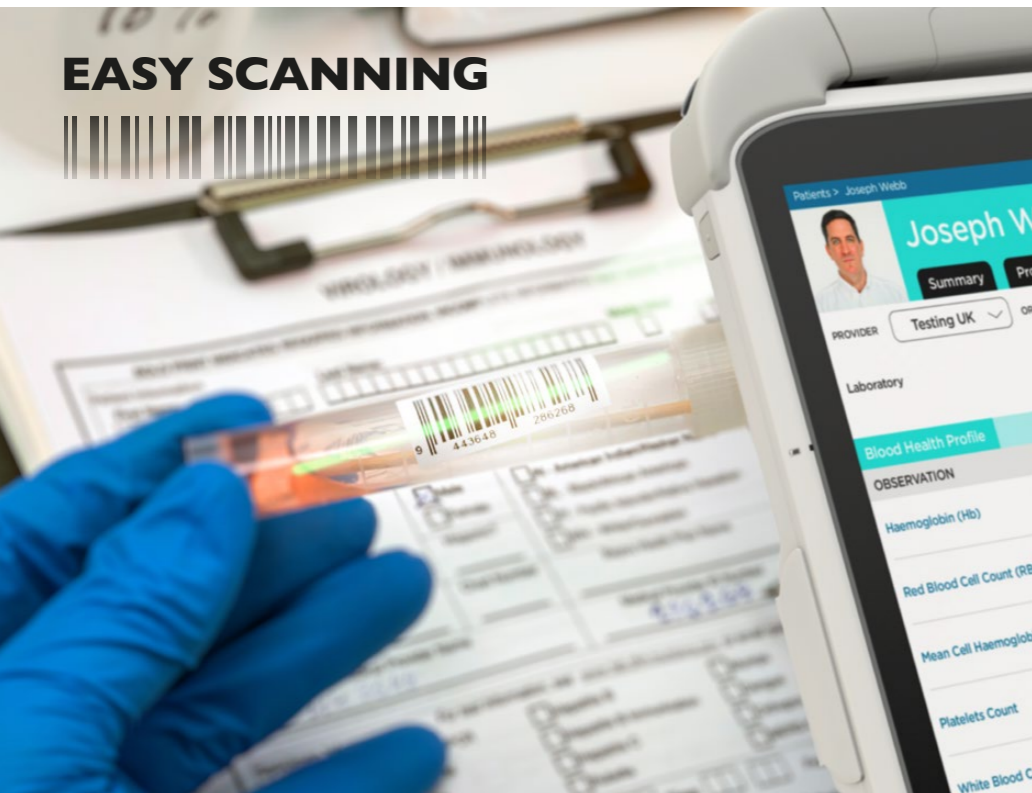

Barcode scanning direct from the tablet!

With the in-built 2D barcode scanner*, the workflow is streamlined by not needing a separate scanner peripheral.

Less cabling and equipment.
More speed and efficiency.

*Scanner must be specified at time of ordering the tablet.



Login as quick as paying for your morning coffee.

It's just a simple tap*

Clinicians simply tap their card or badge to the RFID reader and instantly gain access to the systems they need. The temptation for staff to have to write down sensitive passwords in order to remember them, is therefore removed by default.



*RFID card reader must be specified at time of ordering the tablet.

MT300-13T - i5 PROCESSOR - STORAGE AND MEMORY CHOICE

Choose your performance spec based around the powerful 11th generation Intel® i5 Core™ central processing unit.

Delivered ready to switch on, each Freeway Med-Tech Rugged 2-in-1 Tablet PC is loaded with Windows® 10 IoT Enterprise edition.

A standard warranty of 12 months from date of purchase covers any faulty components or workmanship with the option to extend this by an extra 24 months to 3 years in total from date of purchase.



! Please quote the correct part number opposite when ordering as all units are custom built.

MT300-13T with Intel® i5 Core™ CPU

13.3in Medical Grade Tablet Computer with capacitive touch LCD, Intel® 11th Gen i5 Core™ processor, medical grade AC/DC adapter.



Part Number	Operating System	Storage	RAM	Standard Warranty	Extended Warranty*
MT300-13T-313T-5X-495	Win 10 IoT Enterprise	256GB	8GB	12 months	36 months
MT300-13T-313T-5X-595	Win 10 IoT Enterprise	256GB	16GB	12 months	36 months
MT300-13T-313T-5X-5A5	Win 10 IoT Enterprise	512GB	16GB	12 months	36 months

*Extended Warranty available as a cost option, please enquire for prices at time of order. Extended Warranty must be ordered at time of purchase. Extended Warranty is a 24 month extension on top of the standard 12 months offered, to provide 36 months from date of first purchase.

MT300-13T - i7 PROCESSOR - STORAGE AND MEMORY CHOICE

Choose your performance spec based around the powerful 11th generation Intel® i7 Core™ central processing unit.

Delivered ready to switch on, each Freeway Med-Tech Rugged 2-in-1 Tablet PC is loaded with Windows® 10 IoT Enterprise edition.

A standard warranty of 12 months from date of purchase covers any faulty components or workmanship with the option to extend this by an extra 24 months to 3 years in total from date of purchase.



! Please quote the correct part number opposite when ordering as all units are custom built.

MT300-13T with Intel® i7 Core™ CPU

13.3in Medical Grade Tablet Computer with capacitive touch LCD, Intel® 11th Gen i7 Core™ processor, medical grade AC/DC adapter.



Part Number	Operating System	Storage	RAM	Standard Warranty	Extended Warranty*
MT300-13T-313T-7X-495	Win 10 IoT Enterprise	256GB	8GB	12 months	36 months
MT300-13T-313T-7X-595	Win 10 IoT Enterprise	256GB	16GB	12 months	36 months
MT300-13T-313T-7X-5A5	Win 10 IoT Enterprise	512GB	16GB	12 months	36 months

*Extended Warranty available as a cost option, please enquire for prices at time of order. Extended Warranty must be ordered at time of purchase. Extended Warranty is a 24 month extension on top of the standard 12 months offered, to provide 36 months from date of first purchase.



ACCESSORIES

BATTERIES / CHARGER
KEYBOARDS / MOUSE / TABLET CRADLE



MT202 - LITHIUM-ION BATTERY PACK



RELATED ACCESSORIES *(available separately)*



MT202
6-gang
battery
charger

RELATED PRODUCTS

MT500-24T/22T

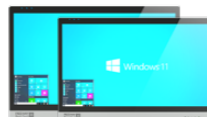

MT700-24T



PRODUCT CODE

MT202 Lithium-ion Rechargeable Battery Pack

The Freeway Med-Tech MT202 Lithium-ion battery packs are for use in our Medical Grade Monitors and AIOs and offer a voltage and capacity spec of DC10.9V 7800mAh - 85Wh. Hot-swappable and featuring internal discharge circuit protection. Charge status LEDs show 4 different stages of the power cycle to aid better charging habits. Charging is supported in-monitor, or externally in our 6-bay charger.

DIMENSIONS

Height = 148.4mm Width = 88.8mm Depth = 19.4mm

PRODUCT ELEVATIONS

Front



W

Side



D

KEY FEATURES

- Hot-swappable
- 4 clear charge status LEDs
- High capacity 7800mAh per pack
- Auto short circuit protection
- Quality Samsung cells used
- Cloth tab for easy removal from monitor/AIO

MT202 - LITHIUM-ION BATTERY PACK

TECHNICAL SPECIFICATIONS

Item	General Parameter	Remark
Description	Freeway Med-Tech Li-ion rechargeable battery MT202 DC10.9V 7800mAh - 85Wh	353P Assembly
Cell Model	Samsung SDI 18650	
Typical Capacity	7800mAh	
Typical Voltage	10.8V	
End of Charge Voltage	12.6V	
Charge Current	0.2C	
Charging time	4.25 hours in monitor from 10% - 90%	Faster off-cart charging available using our external charger
End discharge Voltage	8.4V	
Max continuous charge	3.9A	
Maximum continuous Discharging Current	10A	
Over-discharge Voltage Protection cell	2.8V	
Over-Current Discharge Protection	13-16A	
Short circuit protection	With protection	
Dimension	148.4x88.8x19.4mm	
Weight	435g	
Operating Temperature Range	Charge 0-45C, Discharge 20-60C	



MT202 Batteries shown in a powered monitor MT700-24T (uses up to 3 packs).

SAMSUNG

High quality components

Samsung SDI 18650 cells are used within our battery packs.



On-battery status LEDs

Clear at-a-glance visual of battery health via four LEDs.

- 4 LEDs / 75-100% charged
- 3 LEDs / 50-75% charged
- 2 LEDs / 25-50% charged
- 1 LEDs / 0-25% charged



MT250 - 6-BAY SMART CHARGER



*Battery packs are purchased separately.

RELATED PRODUCTS *(available separately)*

MT202



MT500-24T/22T



MT700-24T



PRODUCT CODE

MT250 6-Bay Smart Charger

The MT250 6-Bay Smart Charger Kit charges the hot-swappable MT202 batteries for the MT700-24T, and MT500-24T series Medical Monitors / AIOs. The Kit includes one battery cradle, an AC-DC adapter, and a power cord.

The battery cradle features a DC-input jack, six battery slots, and six LEDs for power and charging indicators. Connect the AC-DC adapter cable to the DC-input jack and then insert the battery packs in the correct direction into each slot for charging.

After inserting the battery pack in the slot, the charging LED lights up (orange) if the battery pack is being recharged. When charging is complete or if the battery pack is already fully charged, the LED will show solid blue.

DIMENSIONS

Height = **81.6mm** Width = **321mm** Depth = **157.6mm**

PRODUCT ELEVATIONS

Front



Side



MT250 - 6-BAY SMART CHARGER

TECHNICAL SPECIFICATIONS

I/O Ports	
DC-in	1
Charging Slot	6
Mechanical and Environmental	
AC/DC Adaptors	Input: 100 – 240V AC; Output: 19V DC, 10.52A
Dimensions (H x W x D)	81.6 x 321 x 157.6 mm
Weight	1.3kg
Regulatory	FCC Class B, CE, C-Tick, RoHS compliant
Temperature	Operation: 0°C – 40°C; Storage: -20°C – 60°C
Humidity	0% – 90% non-condensing

*Specifications subject to change without notice.



Individual charging status LEDs

PRECAUTIONS

1. Always exercise care when operating and handling.
2. Do not disassemble any portion of the charger and adapter as this will void any product warranty.
3. Do not use any power adapter other than the one provided with the device or acquired from the manufacturer or its partners.
4. In the unlikely event that abnormal noise, strange odour, or smoke is present, immediately disconnect all power sources. Please report the problem to your device provider immediately.



Charging status LEDs

Clear at-a-glance visual of charging status via individual LEDs.

Blue - fully charged battery

Orange - charging battery

INCLUDED IN THE KIT



AC-DC power adaptor with power cord

MT101 - FULLY WATERPROOF BACKLIT KEYBOARD



RELATED PRODUCTS *(available separately)*

MT105



MT102



MT104



PRODUCT CODE

MT101-W-UK Waterproof IP68 backlit keyboard featuring a Cleaning Lock Key

The MT101 Keyboard can be fully submersed in water, making it fantastic for clinical environments and very easy to clean for high traffic clinical use. It's fully tested to IP68 to withstand frequent disinfection and offers Freeway Med-Tech's highest infection control compliance for a keyboard. It offers ergonomic typing, with raised keys for touch type feed back and has an adjustable blue back light which make it great for use at night. It also has the ability to lock the keys for quick cleaning. Another stand out feature is its silent keys - useful for typing in areas that are noise sensitive such as at a patient's bedside.

DIMENSIONS

Height = 10mm Width = 380mm Depth = 130mm

PRODUCT ELEVATIONS

Front



Side



KEY FEATURES

- IP68 – designed for complete immersion in water.
- Cleaning Lock Key - pressing this key for 5 seconds activates cleaning mode that locks all keys. Press again for 5 seconds and the lock is released.
- Rubberised coating for a tactile, quiet typing surface.
- Designed to withstand water; alcohol and disinfectants.
- Adjustable backlit keys - great in dark environments or at night (can be switched on or off).
- Sold at cost price - offers the highest levels of infection prevention across a hospital, at the lowest cost!

MT101 - FULLY WATERPROOF BACKLIT KEYBOARD

TECHNICAL SPECIFICATIONS

Feature	General comment
Connection	Wired
Interface	USB
Dimensions	10x380x130mm (HxWxD)
Weight	720g
Cable Length	180cm
Number of keys	110
Platform	Windows, Mac and Linux
Protection rating	IP68 (fully tested to resist dust and dirt and can fully submersed in water to a depth of 1.5m for 30mins)
Lockable	Yes (5-second press to lock/unlock)
Compliant standards	CE / FCC / RoHS / IP68
Backlight	Yes - blue colour, adjustable brightness, on/off
Warranty	36 months
Operating temperature	-30°C ~ +70°C

*Specifications subject to change without notice.

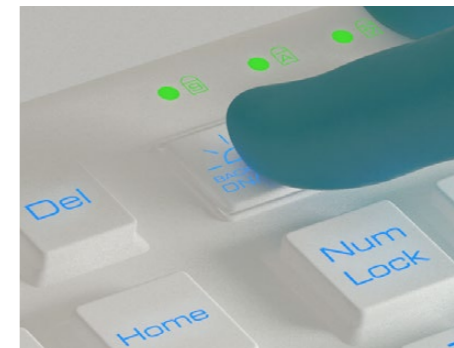

Cleaning Lock Key

Holding this key in for 5 seconds disables all key inputs until it is pressed again. Great for cleaning whilst the keyboard is still plugged in!

Backlit keys on/off

Toggle the keyboard back-light with a simple key switch. The rubber encasing ensures the unit stays waterproof regardless of the keys' up/down state.

IMAGE FAR LEFT

Spillages

Accidental spillages can easily be rinsed off with clean water. Even whilst the keyboard is plugged-in!



Fully waterproof

Not just water resistant or splash proof, this keyboard can withstand being fully immersed in water! This makes cleaning the surface extremely easy and thorough.

*See pages 228/9 for detailed information on cleaning chemicals and procedures.



Backlit keys for nightwork

All keys and status icons are backlit with an adjustable blue light that can be switched on/off as required. It makes working in reduced lighting much easier and more error-free.



Soft silicone encased keys

Our beautifully tactile soft silicone coating not only ensures zero liquid enters the electronics inside, but it also extremely quiet and comfortable to type on.

MT102 - COMPACT WASHABLE KEYBOARD



RELATED PRODUCTS *(available separately)*

MT105



MT101



MT104



PRODUCT CODE

MT102-W-UK Compact Washable keyboard featuring a Cleaning Lock Key

The MT102 Washable Keyboard is designed for use in medical environments and can be fully submersed in water. As it is not fully sealed, its use is not just for clinical areas but where higher volumes of typing need to be combined with the convenience of washing the keyboard under water or cleaning with Alco wipes. It's fully tested to IP68 to withstand frequent disinfection and offers the ability to wash frequently. It also has the ability to lock the keys for quick cleaning.

DIMENSIONS

Height = **28mm** Width = **346mm** Depth = **116mm**

PRODUCT ELEVATIONS

Front



W

Side



D

KEY FEATURES

- Cleaning Lock Key - pressing this key for 5 seconds activates cleaning mode that locks all keys. Press again for 5 seconds and the lock is released.
- IP68 – designed for complete immersion in water.
- Plug and Play via USB
- Antimicrobial coating helps prevent bacteria build-up

MT102 - COMPACT WASHABLE KEYBOARD

TECHNICAL SPECIFICATIONS

Feature	General comment
Connection	Wired
Interface	USB
Dimensions	28x346x116mm (HxWxD)
Weight	560g
Cable Length	150cm
Number of keys	90
Platform	Windows, Mac and Linux
Protection rating	IP68
Lockable	Yes (5-second press to lock/unlock)
Compliant standards	FCC / CE / RoHS / IP68 / Antibacterial
Backlight	No
Warranty	12 months
Operating temperature	-10°C ~ +55°C

*Specifications subject to change without notice.



Cleaning Lock Key

Holding this key in for 5 seconds disables all key inputs until it is pressed again. Great for cleaning whilst the keyboard is still plugged in!

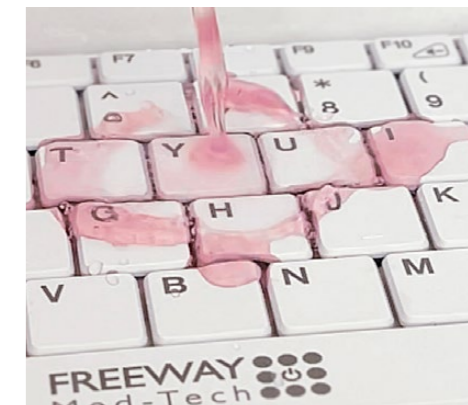

Spillages

Liquids can easily be rinsed off under a tap with clean water and wiped clean.



Waterproof

Can withstand being fully immersed in water at a depth of 1m for 30 minutes!

*See pages 228/9 for detailed information on cleaning chemicals and procedures.

MT104 - WASHABLE KEYBOARD



RELATED PRODUCTS *(available separately)*

MT105



MT101



MT102



PRODUCT CODE

MT104-W-UK Washable keyboard featuring a Cleaning Lock Key

The MT104 Keyboard can be fully submersed in water, as it is not fully sealed, its use is not for clinical areas but where higher volumes of typing need to be combined with the convenience of washing the keyboard under a direct water source or cleaning with Alco wipes, this MT104 is perfect. It's fully tested to IPX7 to withstand frequent disinfection and offers the ability to wash frequently. It offers ergonomic typing, with raised keys for touch type feed back. It also has the ability to lock the keys for quick cleaning.

DIMENSIONS

Height = 20mm Width = 450mm Depth = 162mm

PRODUCT ELEVATIONS

Front



W

Side



D

KEY FEATURES

- Cleaning Lock Key - pressing this key for 5 seconds activates cleaning mode that locks all keys. Press again for 5 seconds and the lock is released.
- IPX7 – A device with a level 7 water resistance rating can survive (without any damage) immersion in water of up to 1m (approx. 3ft) for 30min. All the devices with the IPX7 rating are considered fully waterproof.

MT104 - WASHABLE KEYBOARD

TECHNICAL SPECIFICATIONS

Feature	General comment
Connection	Wired
Interface	USB
Dimensions	20x450x162mm (HxWxD)
Weight	525g
Cable Length	180cm
Number of keys	110
Platform	Windows, Mac and Linux
Protection rating	IPX7
Lockable	Yes (5-second press to lock/unlock)
Compliant standards	CE / RoHS / IPX7
Backlight	No
Warranty	12 months
Operating temperature	-30°C ~ +70°C

*Specifications subject to change without notice.



Cleaning Lock Key

Holding this key in for 5 seconds disables all key inputs until it is pressed again. Great for cleaning whilst the keyboard is still plugged in!



Spillages

Liquids can all easily be rinsed off with clean water and wiped clean.



Waterproof

Can withstand being fully immersed in water at a depth of 1m for 30 minutes!

*See pages 228/9 for detailed information on cleaning chemicals and procedures.

MT105 - FULLY WATERPROOF LASER MOUSE



RELATED PRODUCTS *(available separately)*



PRODUCT CODE

MT105-W Waterproof IP68 easy-clean laser mouse

The MT105 IP68 Laser Mouse is fully waterproof and designed for clinical use as it can be cleaned easily, using popular hospital chemicals. It's sealed to the highest IP68 standards in silicone to withstand frequent disinfection and offers Freeway Med-Tech's highest infection control compliance for a mouse. We are proud of the design and is a result of hundreds of hours of testing in NHS environments, with power needs specially customised to work with our MT700 & MT500 Powered Medical displays. Ideally suited in ICU, Theatres or any area where the risk of contamination is high, and cleaning is constant, requiring a rugged medical mouse.

DIMENSIONS

Height = 42mm Width = 115mm Depth = 68mm

PRODUCT ELEVATIONS



KEY FEATURES

- IP68 Rating – the mouse is completely water tight and so is protected against complete, continuous immersion in water.
- Designed to withstand water, alcohol and hospital disinfectants
- Stylish design and comfortable shape to suit left or right-handed users
- Scrolling touchpad in the middle of the mouse

MT105 - FULLY WATERPROOF LASER MOUSE

TECHNICAL SPECIFICATIONS

Feature	General comment
Connection	Wired
Interface	USB, PS/2
Dimensions	42x115x68 (HxWxD)
Weight	176g
Cable Length	180cm
DPI (resolution)	1000
Tracking Method	Laser
Hand Orientation	Left or Right
Platform	Windows, Mac and Linux
Protection rating	IP68 (fully tested to resist dust and dirt and can fully submersed in water to a depth of 1.5m for 30mins)
Compliant standards	CE / FCC / RoHS / IP68
Warranty	12 months
Operating temperature	0°C ~ 55°C

*Specifications subject to change without notice.



Sealed operation

Both mouse buttons and the scroll wheel are completely sealed underneath the soft waterproof coating leaving no traps for dirt or water ingress.

Fully submersible

Easy cleaning is achieved by wiping the surface over with alcohol wipes. But, if a deep clean is required, then the unit can be submersed in water or cleaner if necessary.



Fully waterproof

The mouse can be fully immersed in water or disinfectant to ensure thorough cleaning.

*See pages 228/9 for detailed information on cleaning chemicals and procedures.



Soft silicone encasing

Our beautifully tactile soft rubber coating not only ensures zero liquid enters the electronics inside, but it also extremely comfortable to hold and use.

MT300 - MAGNETIC BACK-LIT TABLET KEYBOARD



RELATED PRODUCTS *(available separately)*

MT300-I3T



PRODUCT CODE

MT300 Magnetic back-lit tablet keyboard

This optional slim detachable keyboard for our powerful MT300-I3T tablet, allows the user to type more freely and quickly than if using just the tablet's touch screen alone. Better still, if paired with the tablet desktop cradle and a large separate monitor, a true 'desktop' PC experience can be achieved. The keyboard's bright back-lit keys make using it in dimly-lit or late-night ward environments, a much easier task compared with a standard keyboard.

Other great features are the magnetic hinge which magically grip the tablet and helps to locate the electronic contacts ensuring an instant connection - no need for a potentially troublesome bluetooth or wireless 'pairing'. Plus, when the keyboard is in the closed position, it completely covers and protects the tablet's advanced capacitive touch screen!

DIMENSIONS

Height = 217mm Width = 319mm Depth = 9mm

PRODUCT ELEVATIONS

Front



W

Side



D

KEY FEATURES

- Bright back-lit QWERTY keyboard
- Physical electronic (instant) connection with tablet
- Magnetic hinge grips tablet's connecting edge
- Ultra slim design

MT300 - MAGNETIC BACK-LIT TABLET KEYBOARD

TECHNICAL SPECIFICATIONS

I/O Ports	
Magnetic hinge connector	A physical connection for all data and power
Mechanical and Environmental	
Dimensions (H x W x D)	217 x 319 x 9 mm (exc. hinge connector)
Weight	0.6kg

*Specifications subject to change without notice.

Magnetically secured. Physically connected.

The removable keyboard is attached to the MT300 tablet via magnets within the hinge connector, also where the electronic contacts are housed. These gold contacts make a physical connection thereby ensuring the keyboard is 'live' as soon as they touch. No need to wait for pairing and connection as on bluetooth devices. No separate battery or power source is required to use the keyboard.



Easily attach.

Simply move the lower edge of the tablet towards the connector and it will magnetically 'grab' the bar into position.



Flexible.

The silicone interconnect allows the keyboard to move independently of the tablet and effortlessly close.

Magically held closed.

Strategically placed powerful magnetics hold the keyboard against the tablet when not in use.

A screen protector too.

When closed, by default the keyboard offers complete protection for the tablet's screen!

MT350 - TABLET DESKTOP CRADLE



RELATED PRODUCTS *(available separately)*

MT300-13T



TABLET-TO-DESKTOP SETUP



PRODUCT CODE

MT350 Tablet desktop cradle

Quickly convert the MT300-13T tablet PC into a desktop PC with this optional desktop cradle. An aesthetically designed outer casing effortlessly holds our tablet and keeps it sturdy and secured. The tablet is always charging whilst in the cradle and with its expansive I/O, connectivity to screens, keyboards, printers and many other peripherals is never a problem. A high grip and weighted underside keep the cradle from being accidentally moved or knocked over. Extra USB ports on both sides of the cradle make plugging-in the odd storage device or phone charger a swift experience without the need to see behind the unit.

DIMENSIONS

Height = 50mm Width = 182mm Depth = 150mm

PRODUCT ELEVATIONS

Front



W

Side



D

KEY FEATURES

- Great connectivity including accessible side USB ports
- RJ45 Ethernet socket allows reliable high speed network access when tablet docked
- Tablet is always charging whilst docked
- Weighted high-grip safety base

MT350 - TABLET DESKTOP CRADLE

TECHNICAL SPECIFICATIONS

I/O Ports	
USB	x4 USB 2.0 (2 on rear panel, 2 on sides)
HDMI	x1 (on rear panel)
Ethernet (RJ45)	x1 10/100/1000 Gigabit port (on rear panel)
DC-in	x1
Mechanical and Environmental	
Dimensions (H x W x D)	50 x 182 x 150mm
Weight	682g

*Specifications subject to change without notice.



Accessible USB

Both sides of the desktop cradle feature USB ports for peripherals that maybe aren't always plugged in.



Secure weighted base

There's no accidentally knocking the cradle over or off a desk with its high-grip weighted underside.



Ample connectivity options*

With a plentiful supply of ports on both the rear and sides of the cradle, getting connected with peripherals and devices is never a problem.

Comprehensive I/O

The cradle features plenty of ports on both the rear and sides of the unit.

Note the power supply unit does not come with the cradle as standard. The tablet's PSU can be used or another one can be purchased separately.

*See table opposite

THE FREEWAY EASY ROLL-OUT

From pallet to switching on, in under 5 minutes.

We pride ourselves in this unique delivery service, where an iWOW® can be unboxed and commissioned in less time than it takes to make a cup of tea!

Our iWOW®'s come pre-built, pre-cabled and with all IT accessories pre-installed where applicable. There's no need for the hospital's in-house IT or engineers to setup any equipment before installing their software and licenses.

Furthermore, we use around 75% less packaging than other manufacturers and take all of what is used, away with us upon completion of the 'easy roll-out'.

Protected ✓

All iWOWs are delivered by our own transport and decanted by our own staff. This ensures a seamless process between our factory and the customer which leads to less damage and/or delays.



Pre-built ✓

iWOWs arrive fully built and with only minor elements of protective packaging in place for transit.



Pre-cabled ✓

All necessary cabling is installed at the factory leaving no room for error on-site.

It may seem like a trivial element, but anecdotally, this really does save time and costly errors compared with it being done on-site when often being rushed.



IT Pre-installed ✓

All accessory equipment can be pre-installed ready to go ensuring commissioning the iWOW® is a very quick process.



Less packaging ✓ More recycling ✓

We strive to be greener and forward-thinking regards our packaging, which is why we use much less than other manufacturers with similar products. We also take away and re-use, where possible, the protective transit packaging.



Dedicated transport ✓

The customer can always be safe in the knowledge that their new equipment will arrive undamaged.



PRODUCT CLEANING AND USE OF

How often can I clean my iWOW®?

You can clean your medical grade cart and Monitor as often as required. All health care institutions will have a recommended minimum frequency for routine cleaning of various items within their facility. This may be weekly, daily or after each use depending on the risk

involved. Please refer to the table opposite for all safe-use chemicals.



Cleaning the Freeway Med-Tech Medical Grade Monitors and AIO PCs for better infection control

Step 1. Freeway Med-Tech recommend the use of healthcare disposable alcohol based anti-bacterial wipes only on the electrical equipment (approx. 70% alcohol) – such as commonly used Clinell Green Wipes.

Step 2. It is recommended wiping from the front of the screen first in a top to bottom motion and then finish across the bottom (the front panel is IP65 Rated). This methodology is designed to minimise the amount of streaking on the screen and reduce excess moisture collecting on the lower front screen bezel, reducing the risk of moisture entering via the lower I/O, remembering to clean the lower OSD keys in the lower right hand corner. After the front Screen has been cleaned, dispose of this wipe.

Step 3. With a fresh Wipe, clean the rear of the AIO PC (the rear panel is IPX2 rated). To clean the screen of AIO PC for general house keeping - use either a microfibre cloth with an alcohol based cleaning spray (approx. 70% alcohol) or disposable alcohol based cloth.



All monitor/AIO front panels are IP65 Rated

INDUSTRY CHEMICALS

Suitable Cleaning Chemicals

Given the vast range of cleaning products on the market, it is not possible to list all acceptable brands. We can however, confirm that our products are compatible with cleaning products containing the following chemicals or are from popular cleaning brands. Should you require confirmation of suitable products that are not listed, please contact us with the relevant product data sheet and we will confirm suitability with our in-house specialist.

Cleaner	Brand
Viraguard®	Veridien
Sani-Cloth® HB	PDI
Sani-Cloth® PLUS	PDI
Super Sani-Cloth®	PDI
CaviWipes™	Metrex
Super HDQ®L 10	Spartan
Cloro-Wipe Towelette	Surgipath
Healthcare Hydrogen Peroxide Wipes	Clorox Healthcare®
Virex®	Johnson
70% Isopropyl Alcohol	Multiple suppliers
Alcohol Prep Pads	PDI, others

Suitable generic chemicals:

- Alcohol (Ethyl or Isopropyl) Solutions*
- Alcohol Wipes (Ethyl or Isopropyl)*
- Hydrogen Peroxide Solutions*

Cleaning procedure for nylon modified polyester coated surfaces:

- Painted surfaces should be cleaned using a soft damp non abrasive cloth and polished dry
- Continual exposure to wet conditions is likely to result in rusting/or the paint lifting.
ALWAYS DRY THE SURFACE AFTER CLEANING
- Continual use of cleaning products may result in a dulling of the surface.
- DO NOT use solvents, bleach, abrasives, synthetic detergents, wax polishes or aerosol sprays unless otherwise listed in the above list.



*Solutions must ALWAYS be diluted in accordance the with manufacturer's instructions for use on medical products/furniture.

*The application of the cleaning solution MUST be in accordance the with manufacturer's instructions for use on medical products/furniture.

iWOW®

Product range and accessories

Edition 4.1

Freeway Med-Tech
Unit 14,
Colthrop Business Park,
Colthrop Lane, Thatcham,
Berkshire, RG19 4NB.

Tel: 01635 866 717
Fax: 01635 866 347
Web: freewaymedtech.com
Email: sales@freewaymedtech.com

